

Level- and temperature switch

Nivovent NV 71, NV 71D

The oil tank is the key component of hydraulic and lubrication systems. The operating oil is removed from the tank and then returned to it. Depending on what the system is used for, the levels in the oil tank can fluctuate to varying degrees. In most applications, the level fluctuations result in an exchange of the vapour phase above the oil level with the ambient air. Therefore, virtually all oil tanks are equipped with a so-called air breather, to prevent contaminants in the ambient air from entering the system.

To reduce costs and space requirements, a number of other system-related functions such as liquid level and temperature monitoring are also combined in the air breather in the Nivovent series.

NV 71

Connecting flange as per DIN 24557 Part 2

Qualified vent filter with replaceable element

Various plug options

Up to 4 switching outputs or 2 switching outputs for liquid level plus Pt100 or analog output for temperature

Proven and tested highly dynamic float system

Sensor length up to 1.5 m (longer upon request)

Suitable for up to 230 V DC

NV 71D

LED display with switching output status

Qualified vent filter with replaceable element

Visual air breather monitoring optional

Alternatively, continuous temperature output signal (configurable to current or voltage) plus one freely programmable switching output

Characteristics of switching outputs configurable as window or hysteresis

Two switching outputs configurable as frequency output (1-100 Hz)

Standard menu structure based on VDMA standard specification 24574 ff

Min/max value memory, logbook function



Technical Data NV 71
Basic unit

Version	MS	VA
Operating pressure	max. 1 bar	max. 1 bar
Operating temperature	-20 °C to +80 °C	-20 °C to +80 °C
Float	SK 610	SK 221
Min. fluid density	0.80 kg/dm ³	0.85 kg/dm ³
Lengths (all versions)	280, 370, 500 mm (standard) variable to max. 1500 mm	

Material/Version

Float	rigid PU	1.4571
Immersion tube	Brass	1.4571
Flange (DIN 24557)	PA	PA
Weight at L=280 mm	approx. 790 g	approx. 870 g
Each 100 mm add	approx. 30 g	approx. 50 g

Options

Stilling tube (SSR)	Brass	VA
---------------------	-------	----

Vent filter
All versions HY type Hydac BF 7

Filter fineness	3 µm
Additional equipment	Filler cap – n/a with filling adapter

Level switching output
K10
W11

Function	NO / NC*	Change-over contact
Voltage max.	230 V DC	48 V DC
Switching current max.	0.5 A	0.5 A
Contact load max.	10 VA	20 VA
Min. contact spacing	40 mm	40 mm

*NO = falling NC contact / NC = falling NO contact

Optional temperature switching outputs TK
TM

Number of temp. contacts	1	2		
Voltage max.	230 V DC	230 V DC		
Switching current max.	2.5 A	2 A		
Contact load max.	100 VA	100 VA		
Function	NO*	NC*	NO	NC
Switching point °C	50/60/70/80	50/60/70/80	50/60/70/80	50/60/70/80
Switching point - tolerance	± 3 K	± 3 K	± 5 K	± 5 K
Hysteresis max.	10 K ± 3 K	10 K ± 3 K	26/35/40/45 K ± 5 K	18 K ± 5 K

*NO = NO contact / NC = NC contact

Data for rising temperature. Other temperatures and versions with 2 x TK contact available upon request

Temperature sensor

Temperature sensor	Pt 100 Class B, DIN EN 60 751 Tolerance ±0.8 °C
--------------------	--

Temperature transmitter
KT

Temperature sensor	Pt100 Class B, DIN EN 60 751
Measuring range	0 °C to +100 °C
Operating voltage (U _B)	10 - 30 V DC
Output	4 - 20 mA
Burden Ω max.	= (U _B - 7.5 V) / 0.02 A
Accuracy	± 1 % from end value
Other measuring ranges available upon request	

Dimensions NV 71

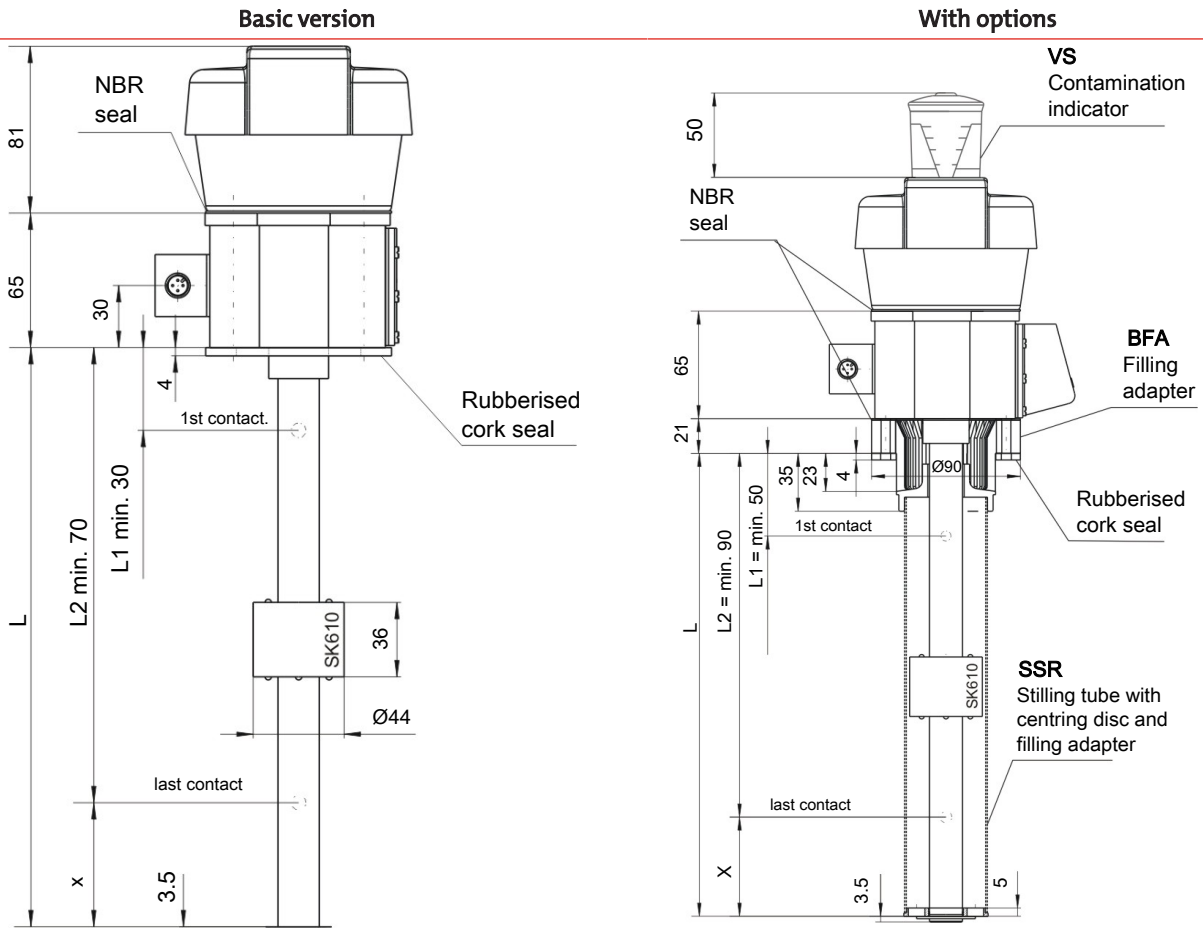

Flange drawing

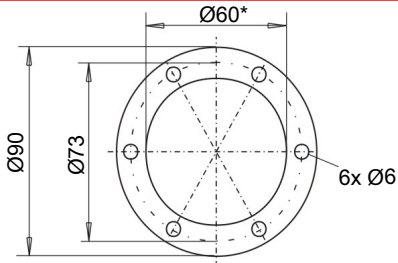

*min. Ø61 for VA version with stilling tube

SK 610 float for NV 71--MS

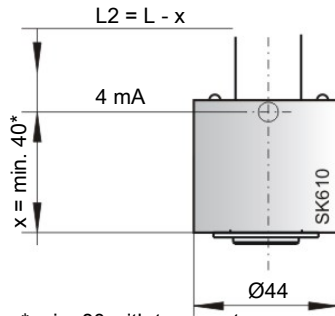

* min. 80 with temperature

SK 221 float for NV 71-VA

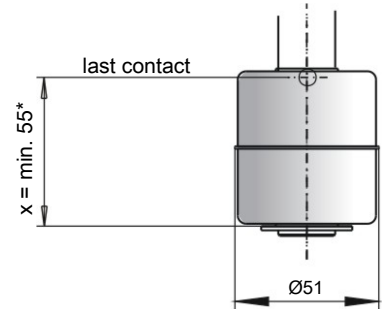

* min. 80 with temperature

Ordering instructions NV 71

Options / Accessories

- VS** Visual air breather **clogging indicator**: Analogue underpressure indicator, display range 0.35 bar.
- BFA*** **Filling adapter** incl. ribbed flange with sieve insert: This option allows adding small oil quantities via the air breather housing. The corresponding housing is therefore equipped with that version.
- SSR*** **Stilling tube** with support ring and filling adapter: This includes the optional stilling tube as well as the same filling option as the BFA. The stilling tube is made of the same material as the requested immersion tube (MS/VS).
- MT** For integration in **Multiterminal**: The basic unit will be mounted to the Multiterminal (MT). For specification please refer to the Multiterminal data sheet.
- MTS** For integration in **Multiterminal including stilling tube**: In addition to the basic unit, a stilling tube with centring rod is installed in the Multiterminal.
- FCT** **Fluid control terminal**: Here the fluid control terminal (FCT) mounts directly onto the basic version. For details please refer to the fluid control terminal data sheet.

* not available in conjunction with FCT and MT/MTS option.

Type plate

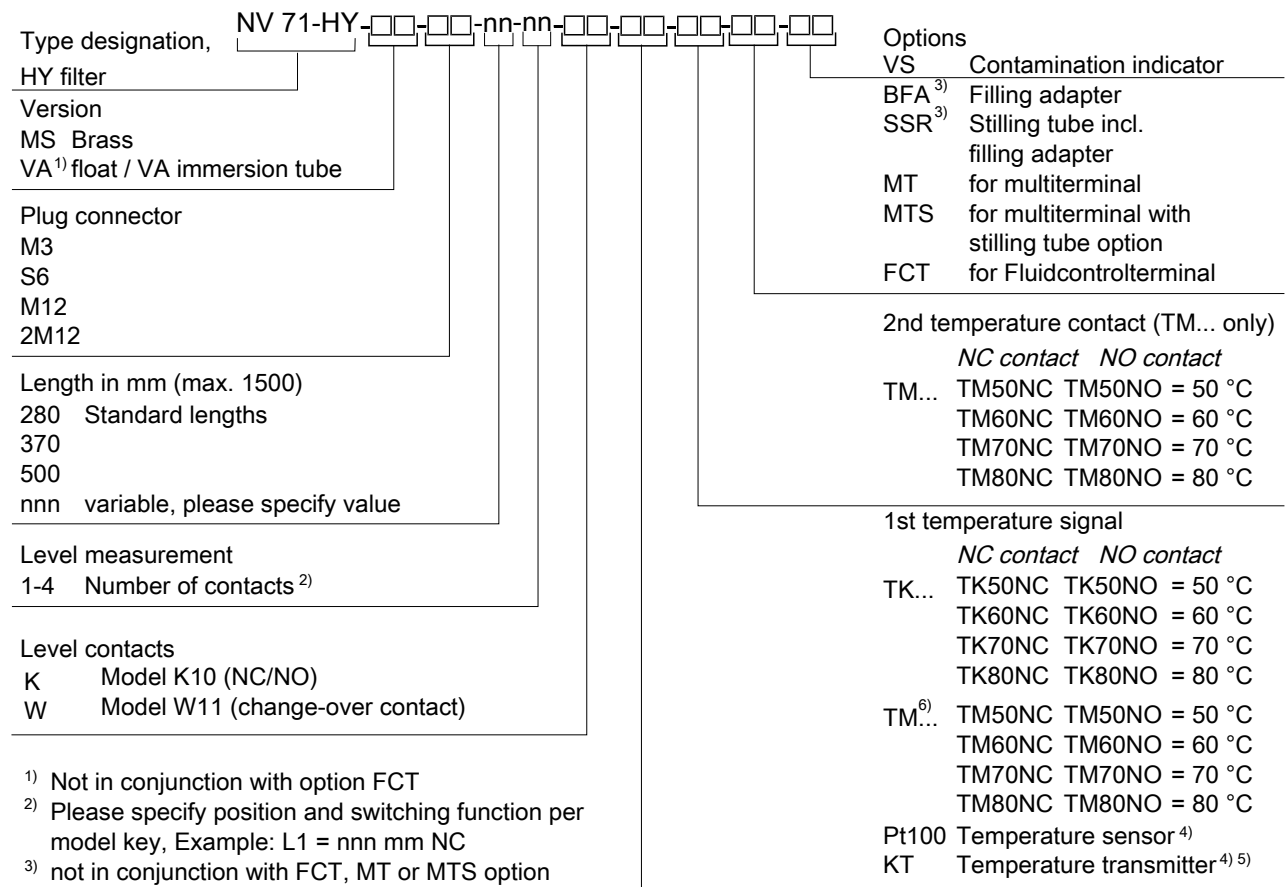

¹⁾ Not in conjunction with option FCT
²⁾ Please specify position and switching function per model key, Example: L1 = nnn mm NC
³⁾ not in conjunction with FCT, MT or MTS option
⁴⁾ Cannot be combined with temperature contact
⁵⁾ With KT only 10 - 30 V DC
⁶⁾ For version with two temperature contacts

Accessories

Item no.	Description
9144 05 0010	Connecting cable M12x1, 4-pin, 1.5 m, angular coupling and straight plug
9144 05 0046	Connecting cable M12x1, 4-pin, 3.0 m, angular coupling and straight plug
9144 05 0047	Connecting cable M12x1, 4-pin, 5.0 m, angular coupling and strands

Ordering example

You require: Brass level switch with vent filter and contamination indicator, L=500 mm, 2 level contacts and temperature contact TK80 °C as NC contact, 1st contact: 100 mm falling NO contact. 2nd contact: 420 mm falling NC contact.

Order: NV 71-HY-MS-S6-500-2K-TK80NC-VA, L1=100 NC, L2=420 NO

Standard pin assignment NV 71

Plug connection

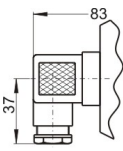
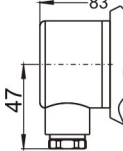
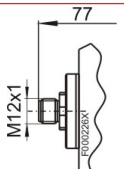
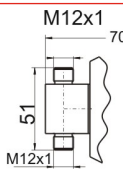
	M3	S6	M12 (base)	2xM12 (base)
Dimensions				
Number of pins	3-pin + PE	6-pin + PE	4-pin	4-pin / 4-pin
DIN EN	175301-803	175201-804	61076-2-101	61076-2-101
Max. voltage	230 VAC / DC*	230 VAC / DC*	30 V DC	30 V DC
IP rating	IP65	IP65	IP67**	IP67**
Cable fitting	PG 11	M20 x 1.5		
Max. Number of contacts				
Level/temp. contacts	1 x K10 / 1 x TK - / - - / -	3 x K10 / 1 x TK 2 x K10 / 2 x TM 1 x W11 / 1 x TK 1 x W11 / 2 x TM	1 x K10 / 1 x TK - / - - / -	3 x K10 / 1 x TK 2 x K10 / 2 x TM 1 x W11 / 1 x TK 1 x W11 / 2 x TM
Level contacts only	2 x K10 1 x W11	4 x K10 2 x W11	2 x K10 1 x W11	4 x K10 2 x W11

*Max. 48 VAC/ VDC for change-over contact. ** With moulded cable box. Other plug connections available upon request

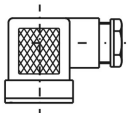
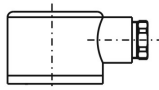
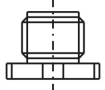
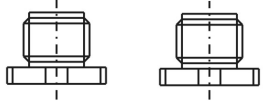
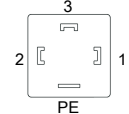
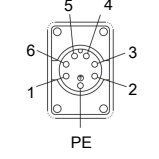
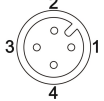
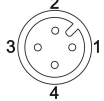
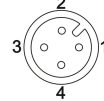
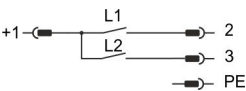
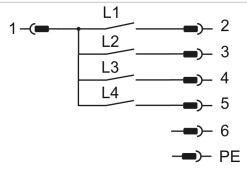
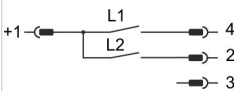
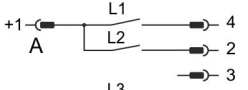
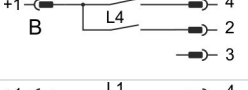
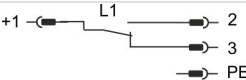
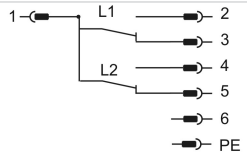
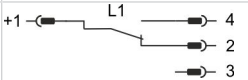
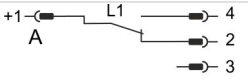
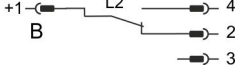
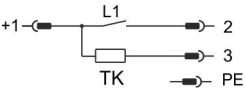
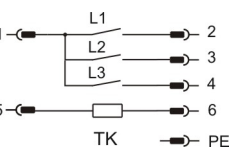
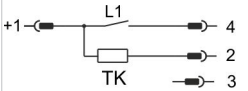
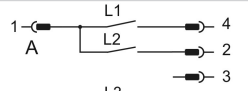
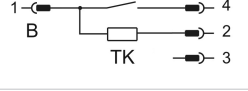
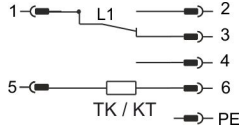
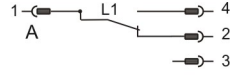
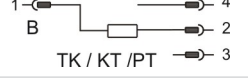
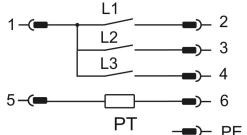
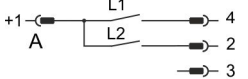
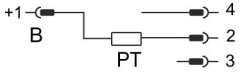
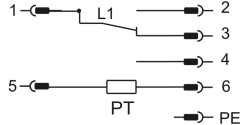
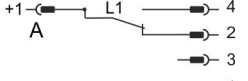
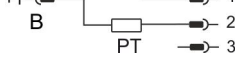
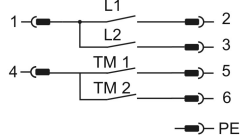
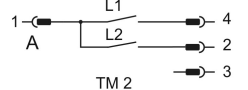
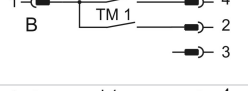
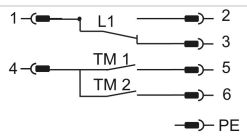
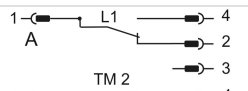
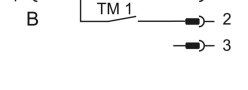
	M3	S6	M12 (base)	2 x M12 (base)
				
Connection schematic				<div style="display: flex; justify-content: space-around;"> <div style="text-align: center;">  <p>Plug A</p> </div> <div style="text-align: center;">  <p>Plug B</p> </div> </div>
K10 Level contact(s)				<div style="display: flex; flex-direction: column; align-items: center;"> <div style="text-align: center;">  <p>A</p> </div> <div style="text-align: center;">  <p>B</p> </div> </div>
W11 Level contact(s)				<div style="display: flex; flex-direction: column; align-items: center;"> <div style="text-align: center;">  <p>A</p> </div> <div style="text-align: center;">  <p>B</p> </div> </div>
K10 Level- and temperature contact				<div style="display: flex; flex-direction: column; align-items: center;"> <div style="text-align: center;">  <p>A</p> </div> <div style="text-align: center;">  <p>B</p> </div> </div>
W11 Level- and temperature contact(s)				<div style="display: flex; flex-direction: column; align-items: center;"> <div style="text-align: center;">  <p>A</p> </div> <div style="text-align: center;">  <p>B</p> </div> </div>
K10 / Pt100 Level- and temperature contact(s)				<div style="display: flex; flex-direction: column; align-items: center;"> <div style="text-align: center;">  <p>A</p> </div> <div style="text-align: center;">  <p>B</p> </div> </div>
W11 / Pt100 Level- and temperature contact(s)				<div style="display: flex; flex-direction: column; align-items: center;"> <div style="text-align: center;">  <p>A</p> </div> <div style="text-align: center;">  <p>B</p> </div> </div>
K10 Level and 2 x temperature contact(s)				<div style="display: flex; flex-direction: column; align-items: center;"> <div style="text-align: center;">  <p>A</p> </div> <div style="text-align: center;">  <p>B</p> </div> </div>
W11 Level and 2 x temperature contact(s)				<div style="display: flex; flex-direction: column; align-items: center;"> <div style="text-align: center;">  <p>A</p> </div> <div style="text-align: center;">  <p>B</p> </div> </div>

The standard assignment specified here refers to the max. number of contacts possible and contact function NO (contact type K10).

Technical Data NV 71D
Basic unit

Version	MS	VA
Operating pressure	max. 1 bar	max. 1 bar
Operating temperature	-20 °C to +80 °C	-20 °C to +80 °C
Float	SK 610	SK 221
Min. fluid density	0.80 kg/dm ³	0.85 kg/dm ³
Lengths (all versions)	280, 370, 500 (Standard), variable to max. 1500	

Material/Version

Display housing	PA	PA
Float	rigid PU (SK 601)	1.4571 (SK 221)
Immersion tube	Brass	1.4571
Flange (DIN 24557)	PA	PA
Weight at L=280 mm	approx. 825 g	approx. 910 g
Each 100 mm add	approx. 30 g	approx. 50 g
Degree of protection	IP65	IP65

Includes:

Mounting screws (quantity 6) and rubberised cork seal

Options

Stilling tube (SSR)	Brass	VA
---------------------	-------	----

Vent filter

All versions HY type Hydac BF 7

Filter fineness	3 µm
Additional equipment	Filler cap – n/a with filling adapter

Temperature display electronics

Display	4 character 7 segment LED
Operation	Via 3 keys
Memory	Min. / Max. Data memory
Starting current input	approx. 100 mA for 100 ms
Current input during operation	approx. 50 mA (without current- and switching outputs)
Supply voltage (U _B)	10 – 30 V DC (nominal voltage 24 V DC)
Ambient temperature	-20 °C to +70 °C
Display units	Temperature °C / °F
Display range	-20 °C to +120 °C
Alarm setting range	0 °C to 100 °C
Display accuracy	± 1 % from end value

Temperature sensor

Pt 100 Class B, DIN EN 60751
Resolution 0.5 °C

Level switching output

K10

Max. number	2
Function	NC / NC*
Function	NC / NC*
Switching current max.	0.5 A
Contact load max.	10 VA
Min. contact spacing	40 mm

*NO= falling NC contact / NC = falling NO contact

Temperature outputs

Choose from the following temperature outputs

	-2T	-1T-KT	-4T
Plug (base)	2 x M12 – 4-pin	2 x M12 – 4-pin	1 x M12 – 4-pin 1 x M12 – 8-pin
Switching outputs	2 x freely programmable*	1 x freely programmable*	4 x freely programmable
Alarm memory		with 1 x assignable to alarm logbook	with 1 x assignable to alarm logbook
max. switching current**	0.5 A per output continuous short-circuit protected	0.5 A per output continuous short-circuit protected	0.5 A per output continuous short-circuit protected
Contact load	max. 1 A total	max. 1 A total	max. 1 A total
Analogue output		Analogue output	
Max. burden Ω as current output		$= (U_B - 8 V) / 0.02 A$	
Min. input load as voltage output		10 k Ω	

*also programmable as frequency output

**Output 1 max. 0.2 A.

Dimensions NV 71D

Basic version

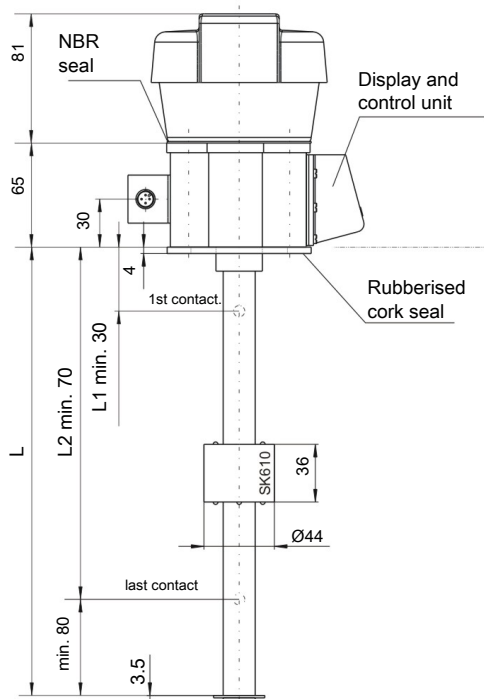

With options

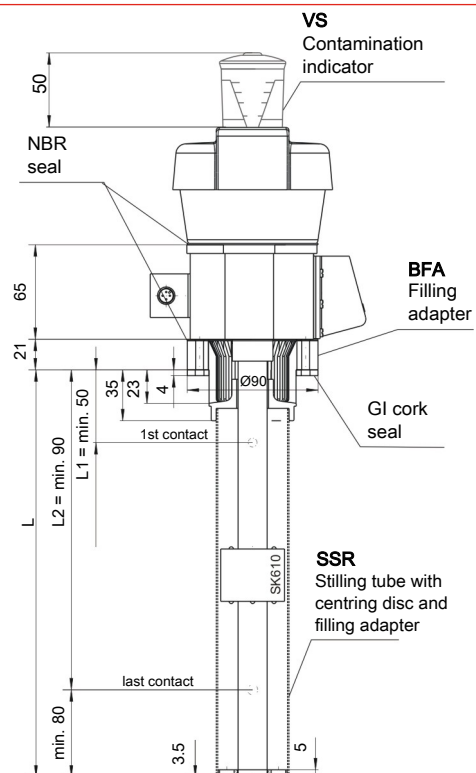

Flange drawing

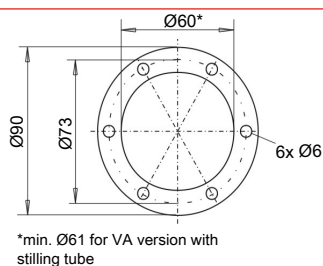

Float for NV 71D-VA

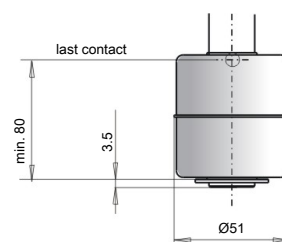

Ordering instructions NV 71D

Options / Accessories

- VS** Visual air breather **clogging indicator**: Analogue underpressure indicator, display range 0.35 bar.
- BFA*** **Filling adapter** incl. ribbed flange with sieve insert: This option allows adding small oil quantities via the air breather housing. The corresponding housing is therefore equipped with that version.
- SSR*** **Stilling tube** with support ring and filling adapter: This includes the optional stilling tube as well as the same filling option as the BFA. The stilling tube is made of the same material as the requested immersion tube (MS/VS).
- MT** For integration in **Multiterminal**: The basic unit will be mounted to the Multiterminal (MT). For specification please refer to the Multiterminal data sheet.
- MTS** For integration in **Multiterminal including stilling tube**: In addition to the basic unit, a stilling tube with centring rod is installed in the Multiterminal.
- FCT** **Fluid control terminal**: Here the fluid control terminal (FCT) mounts directly onto the basic version. For details please refer to the fluid control terminal data sheet.

* not available in conjunction with FCT and MT/MTS option.

Model key

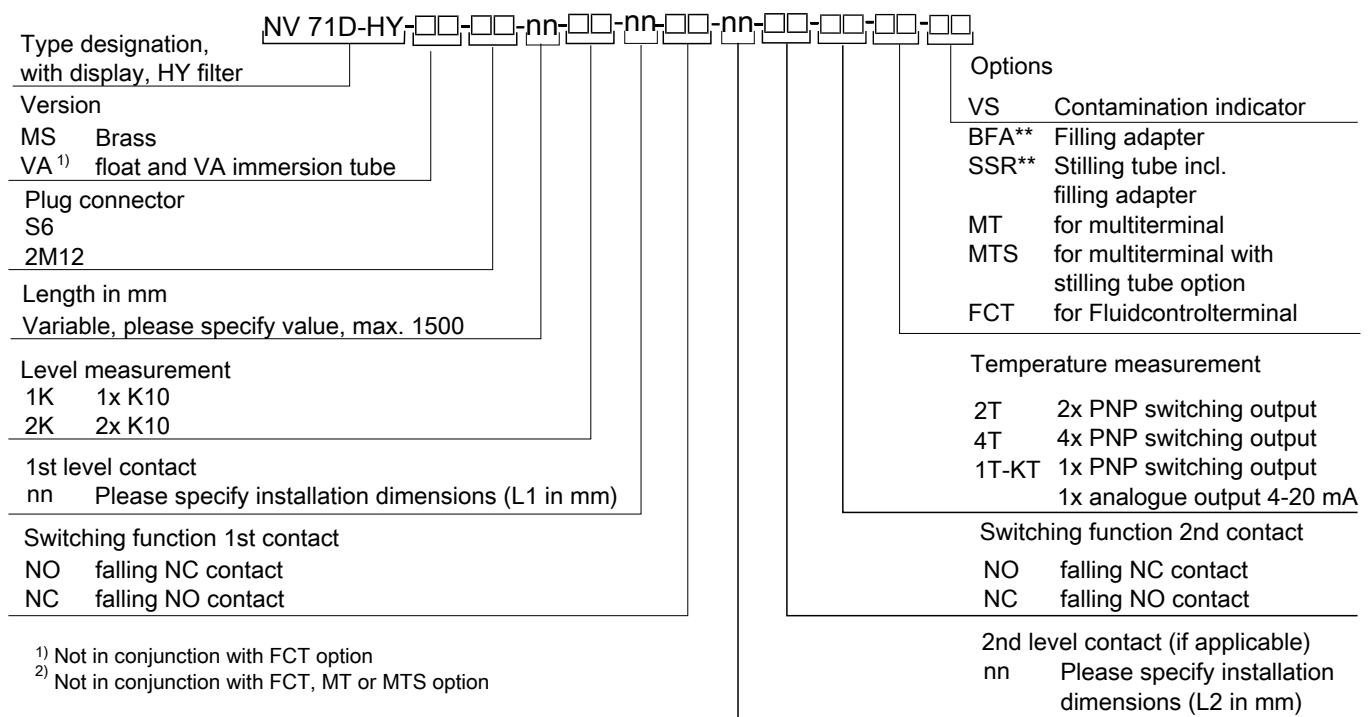

Accessories

Item no. 4-pin	Item no. 8-pin	Description
9144 05 0010	9144 05 0048	Connecting cable M12x1, 1.5 m, angular coupling and straight plug
9144 05 0046	9144 05 0049	Connecting cable M12x1, 3.0 m, angular coupling and straight plug
9144 05 0047	9144 05 0033	Connecting cable M12x1, 5.0 m, angular coupling and strands

Ordering example

You require: Stainless steel level switch with vent filter and contamination indicator, length L = 500 mm, 2 level contacts, 1st contact: 100 mm falling NO contact, 2nd contact: 420 mm falling NC contact, 2 temperature outputs

Order: NV 71D-HY-VA-2M12-500-2K-100 NC-420 NO-2T-VS

Standard pin assignment NV 71D

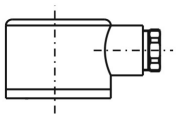
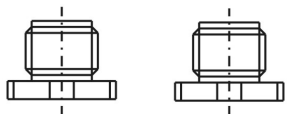
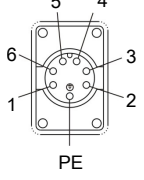
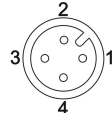
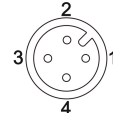
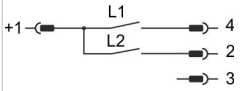
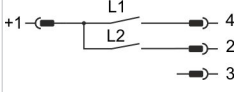
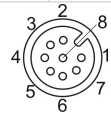
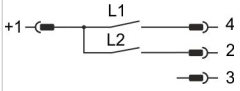
Plug connection		S6	2xM12	
				
Connection schematic			Plug A (level) 	Plug B (temperature) 
2T	Pin			Pin
2 x temperature output	1 +24 V DC 2 2 GND 3 S1 (PNP) 4 S2 (PNP) 5 L1 6 (L2)			1 +24 V DC 2 2 Analogue (out) 3 GND 4 S1 (PNP)
1T-KT	Pin			Pin
1 x temperature output, 1 x analogue output	1 +24 V DC 2 2 GND 3 S1 (PNP) 4 Temp (analogue) 5 L1 6 (L2)			1 +24 V DC 2 2 Analogue (out) 3 GND 4 S1 (PNP)
Connection schematic				
4T	Pin			Pin
4 x temperature output				1 +24 V DC 2 S2 (PNP) 3 GND 4 S1 (PNP) 5 S3 (PNP) 6 S4 (PNP)

When measuring the switching output with high-load measuring device inputs or when used as a frequency output, the load must be set to 10 kΩ between the output and earth (GND) to avoid faulty measurements.