

# Level- and temperature switch

## Nivotemp NT 64, NT 64D

In hydraulics and lubrication technology the fill level of oil tanks needs to be monitored continuously. Here, modern factory automation requires compatible signals. Despite central system control, visualising the current level on the actual tanks is often desired. To minimise production costs and the space required on containers, it makes sense to use one monitor for both e.g. the fill level and oil temperature. The Nivotemp series meets virtually all requirements arising in this area of application.

### NT 64

Connecting flange as per DIN 24557 Part 2

Wireless, adjustable level contacts

Various plug options

Up to 4 switching outputs for liquid level or 2 switching outputs for liquid level plus Pt100 or analog output for temperature

Proven and tested highly dynamic float system

24 V DC standard, 230 V DC upon request

### NT 64D

LED display with status of switching outputs, 270° swivel

Standard menu structure based on VDMA standard sheet 24574 ff.

2 wireless, adjustable level contacts

Up to 4 programmable temperature switching outputs

Alternatively, continuous temperature output signal plus one freely programmable switching output

Characteristics of switching output configurable as window or hysteresis

Two switching outputs configurable as frequency output (1-100 Hz)

Min/max memory, logbook function



## Technical Data NT 64

### Basic unit

Version	MS	VA
Operating pressure	max. 1 bar	max. 1 bar
Operating temperature	-20 °C to +80 °C	-20 °C to +80 °C
Float	SK 610	SK 221
Min. fluid density	0.80 kg/dm <sup>3</sup>	0.85 kg/dm <sup>3</sup>
Lengths	280, 370, 500 mm (standard)	

### Material/Version

Float	rigid PU (SK 610)	1.4571 (SK 221)
Immersion tube	Brass	1.4571
Flange (DIN 24557)	PA	PA
Weight at L=280 mm	approx. 200 g	approx. 300 g
Each 100 mm add	approx. 30 g	approx. 50 g

### Includes:

Mounting screws (quantity 6) and rubberised cork seal.

### Options

Stilling tube (SSR)	Brass	VA
<b>Level switching output</b>	<b>K101-104</b>	<b>W101/102</b>
Function	NO/NC*	Change-over contact
Max. number	4	2
Voltage max.	30 V DC	30 V DC
Switching current max.	0.5 A	0.5 A
Contact load max.	10 VA	20 VA
Min. contact spacing	40 mm	40 mm

\*NO= falling NC contact/NC = falling NO contact

### Optional temperature output

Temperature contact	TK	
Voltage max.	30 V DC	
Switching current max.	2.5 A	
Contact load max.	100 VA	

Function	NC*	NO*
Switching point °C	50/60/70/80	50/60/70/80
Switching point tolerance	± 3 K	± 3 K
Hysteresis max.	10 K ± 3 K	10 K ± 3 K

\* NC = NC contact/NO = NO contact, data for rising temperature

<b>Temperature sensor</b>	Pt 100 Class B, DIN EN 60 751
Tolerance	±0.8 °C

<b>Temperature transmitter</b>	KT
--------------------------------	----

Temperature sensor	Pt 100 Class B, DIN EN 60 751
--------------------	-------------------------------

Measuring range	0 °C to +100 °C
-----------------	-----------------

Supply voltage (U <sub>B</sub> )	10 - 30 V DC
----------------------------------	--------------

Output	4 - 20 mA
--------	-----------

Burden Ω max.	=(U <sub>B</sub> -7.5 V)/0.02 A
---------------	---------------------------------

Accuracy	± 1% from end value
----------	---------------------

Other measuring ranges available upon request

### Basic model

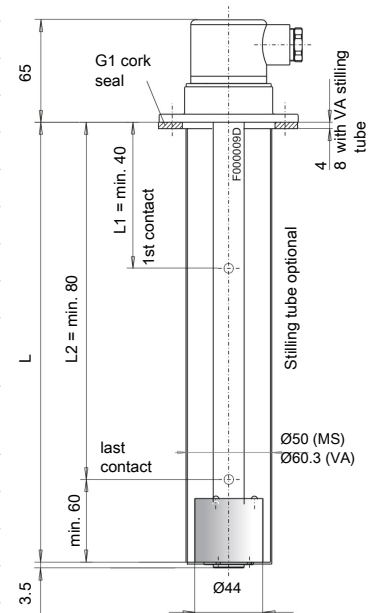

### Flange drawing

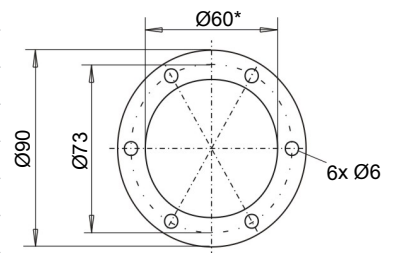

\*min. Ø61 for VA version with stilling tube

### SK 221 Float

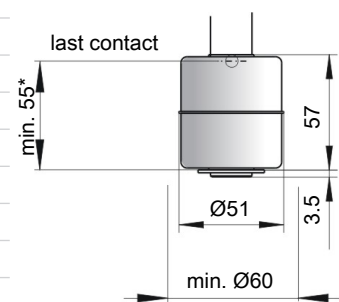

min. Ø61 with stilling tube

\* min. 80 with temperature

## Ordering instructions NT 64

### Model key

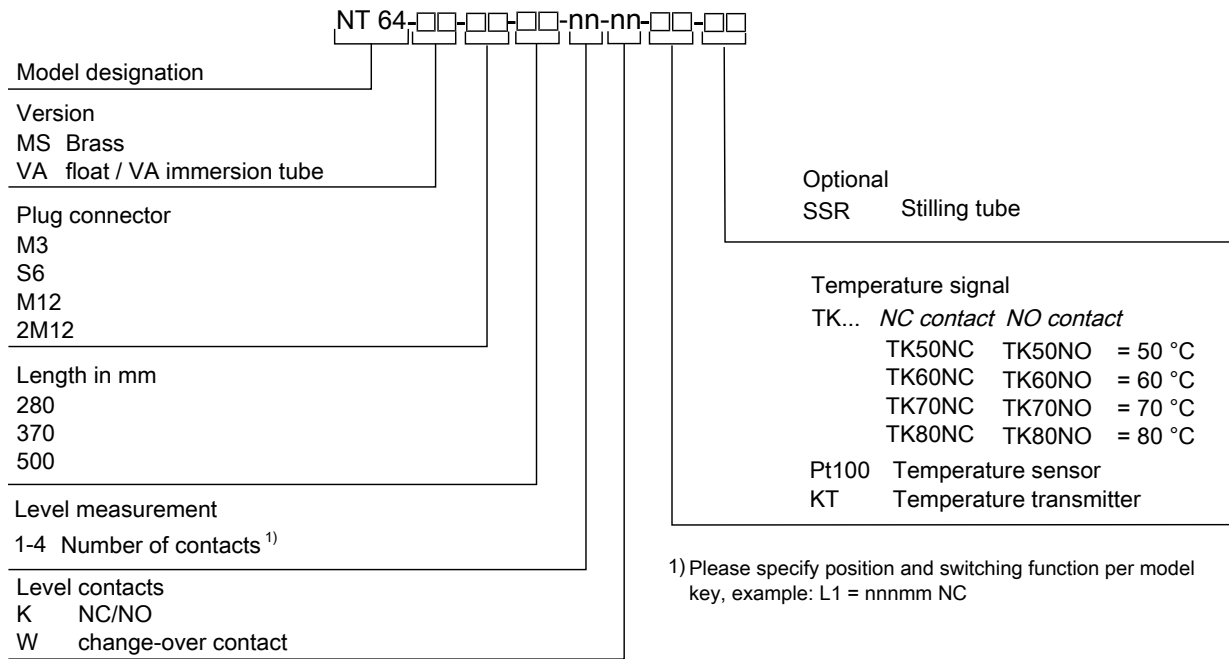

### Accessories

Item no.	Description
9144 05 0010	Connecting cable M12x1, 4-pin, 1.5 m, angular coupling and straight plug
9144 05 0046	Connecting cable M12x1, 4-pin, 3.0 m, angular coupling and straight plug
9144 05 0047	Connecting cable M12x1, 4-pin, 5.0 m, angular coupling and strands

### Ordering example

You require:	Level switch with flange, brass, plug connector S6, length L = 500 mm, 2 level contacts and temperature contact TK 80 as NC contact, 1st contact 100 mm NC, 2nd contact 420 mm NO
Order:	NT 64-MS-S6-500-2K-TK80NC, L1=100 NC, L2=420 NO

## Standard pin assignment NT 64

### Plug connection

	M3	S6	M12 (base)	2M12 (base)
Dimensions				
Number of pins	3-pin + PE	6-pin + PE	4-pin	4-pin / 4-pin
DIN EN	175301-803	175201-804	61076-2-101	61076-2-101
Voltage max.	30 V AC / V DC	30 V AC / V DC	30 V DC	30 V DC
Contact load max.	0.5 A per output	0.5 A per output	0.5 A per output	0.5 A per output
Degree of protection	IP65	IP65	IP67*	IP67*
Cable fitting	PG11	M20x1.5		
Max. number of contacts				
Level/temp. contacts	1 x K101 / 1 x TK - / -	3 x K101-104 / 1 x TK 1 x W101/102 / 1 x TK	1 x K101 / 1 x TK - / -	3 x K101-104 / 1 x TK 1 x W101/102 / 1 x TK
Level contacts only	2 x K101-102 1 x W101	4 x K101-104 2 x W101/102	4 x K101-102 2 x W101	4 x K101-104 1 x W101/102

\* With moulded cable box. Other plug connections available upon request

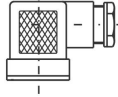
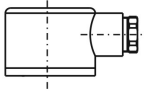
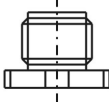
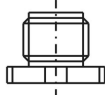
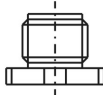
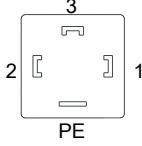
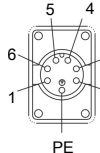
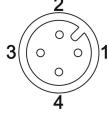
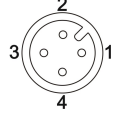
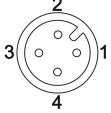
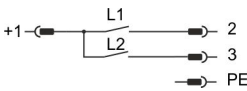
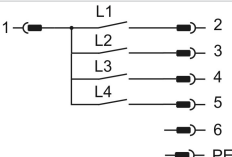
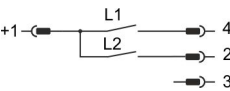
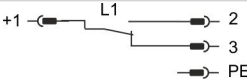
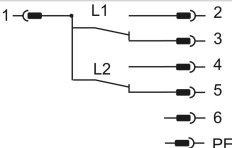
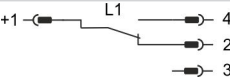
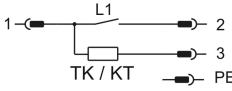
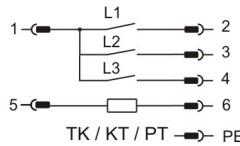
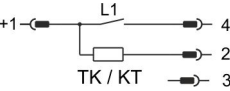
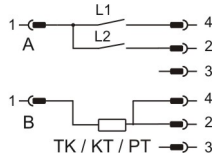
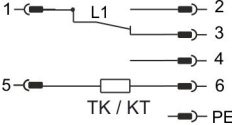
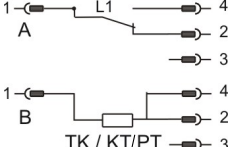
	M3	S6	M12 (base)	2 x M12 (base)	
					
Connection schematic					
<b>K101-104</b> Level contact(s)					
<b>W101/102</b> Level contact(s)					
<b>K101-104</b> Level contact(s) and Pt100					
<b>W101/102</b> Level- and temperature contact(s)					

The standard assignment specified here applies to the max. number of contacts possible and contact function NO.

## Technical Data NT 64D

### Basic unit

Version	MS	VA
Operating pressure	max. 1 bar	max. 1 bar
Operating temperature	-20 °C to +80 °C	-20 °C to +80 °C
Float	SK 610	SK 221
Min. fluid density	0.80 kg/dm <sup>3</sup> with float	0.85 kg/dm <sup>3</sup> with float
Lengths	280, 370, 500 mm (standard)	

### Material/Version

Material/Version	MS	VA
Display housing	PA	PA
Float	rigid PU	1.4571
Immersion tube	Brass	1.4571
Flange (DIN 24557)	PA	PA
Weight at L=280 mm	approx. 300 g	approx. 400 g
Each 100 mm add	approx. 30 g	approx. 50 g
Degree of protection	IP65	IP65

### Includes:

Mounting screws (quantity 6) and rubberised cork seal.

### Options

Option	MS	VA
Stilling tube (SSR)	Brass	VA

### Temperature display electronics

Display	4 character 7 segment LED
Operation	Via 3 keys
Memory	Min. / Max. Data memory
Starting current input	approx. 100 mA for 100 ms
Current input during operation	approx. 50 mA (without current- and switching outputs)
Supply voltage (U <sub>b</sub> )	10 – 30 V DC (nominal voltage 24 V DC)
Ambient temperature	-20 °C to +70 °C
Display units	Temperature °C / °F
Display range	-20 °C to +120 °C
Alarm setting range	0 °C to 100 °C
Display accuracy	± 1 % from end value

**Temperature sensor** Pt100 Class B, Din EN 60751

### Level switching output

Level switching output	K10
Max. number	2
Function	NC / NC*
Voltage max.	30 V DC
Switching current max.	0.5 A
Contact load max.	10 VA
Min. contact spacing	40 mm

\*NO= falling NC contact / NC = falling NO contact

Basic model

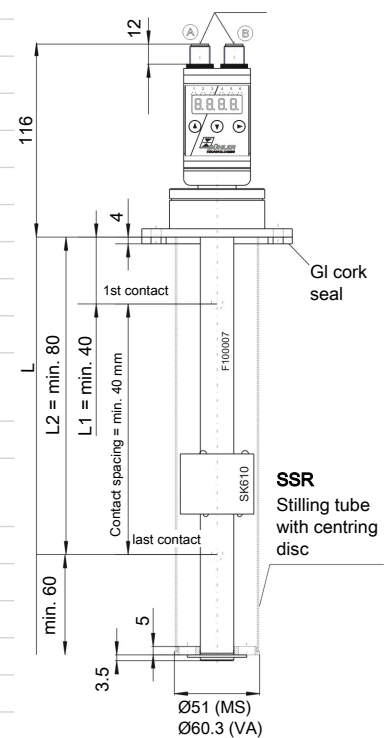

Housing swivels 270°

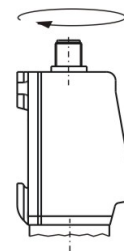

Flange drawing

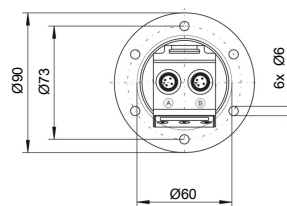

SK 221 float for NT 64D-VA

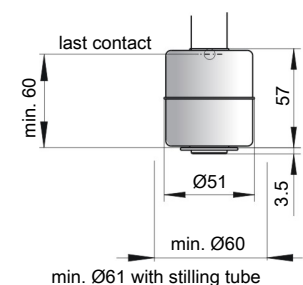

## Temperature outputs

Choose from the following temperature outputs

	-2T	-1T-KT	-4T
Plug (base)	2 x M12 – 4-pin	2 x M12 – 4-pin	1 x M12 – 4-pin 1 x M12 – 8-pin
<b>Switching outputs</b>	2 x freely programmable*	1 x freely programmable*	4 x freely programmable
max. switching current**	0.5 A per output continuous short-circuit protected	0.5 A per output continuous short-circuit protected	0.5 A per output continuous short-circuit protected
Contact load	max. 1 A total	max. 1 A total	max. 1 A total
Analogue output		1 x 4 – 20 mA, 2- 10 V 0-10 V, 0-5 V	
Max. burden $\Omega$ as current output		= $(U_b - 8 \text{ V}) / 0.02 \text{ A}$	
Min. input load as voltage output		10 k $\Omega$	
<b>Options</b>			
Stilling tube (SSR)	Same material as immersion tube		

\*also programmable as frequency output

\*\*Output 1 max. 0.2 A.

## Ordering instructions NT 64D

### Model key

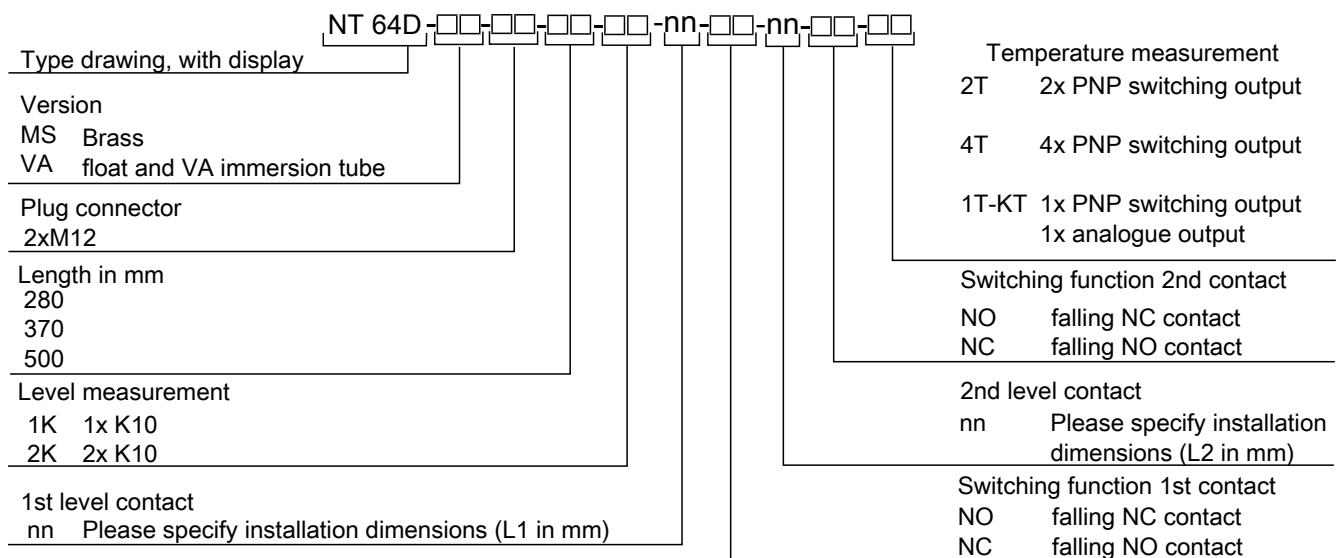

### Accessories

Item no. 4-pin	Item no. 8-pin	Description
9144 05 0010	9144 05 0048	Connecting cable M12x1, 1.5 m, angular coupling and straight plug
9144 05 0046	9144 05 0049	Connecting cable M12x1, 3.0 m, angular coupling and straight plug
9144 05 0047	9144 05 0033	Connecting cable M12x1, 5.0 m, angular coupling and strands

### Ordering example

You require: Level switch with flange, brass, plug connector S6, length L = 500 mm, 2 level contacts and temperature contact TK 80 as NC contact, 1st contact 100 mm NC, 2nd contact 420 mm NO, with temperature display and 2 x programmable temperature output

Order: NT 64D-MS-2M12/500-2K-100NC-420NO-2T

Standard pin assignment NT 64D

Plug connection

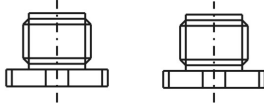
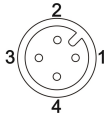
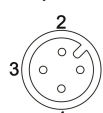
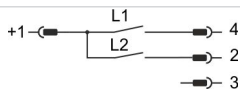
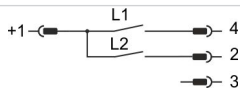
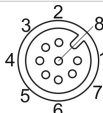
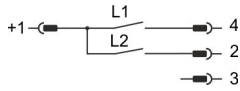
		2 x M12 (base)	
Panel plug			
Connection schematic	<p>Plug A (level)</p> 	<p>Plug B (Temperature)</p> 	
<b>2T</b>		<b>Pin</b>	
2 x temperature output		1 +24V DC 2 S2 (PNP) 3 GND 4 S1 (PNP)	
<b>1T-KT</b>		<b>Pin</b>	
1 x Temperature output 1 x Analogue output		1 +24 V DC 2 Analogue (out) 3 GND 4 T1 (PNP)	
Connection schematic			
<b>4T</b>		<b>Pin</b>	
4 x Temperature output		1 +24 V DC 2 S2 (PNP) 3 GND 4 S1 (PNP) 5 S3 (PNP) 6 S4 (PNP)	

## easyjust System

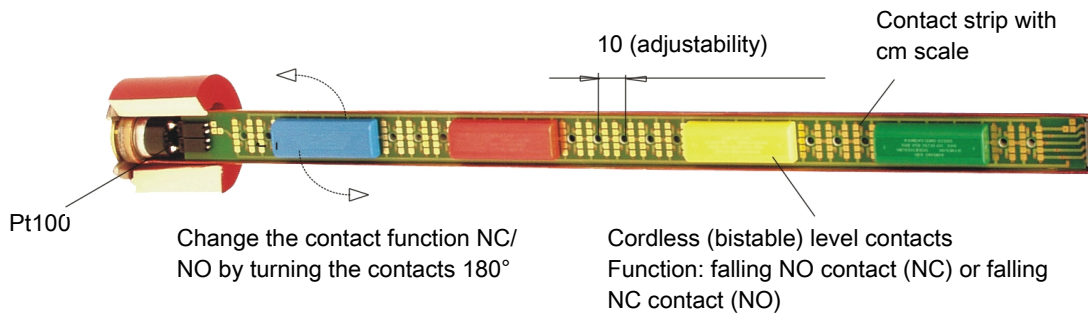

Using adjustable level contacts allows the use of standardised immersion tube lengths for different size and shape oil tanks.

The switching points can always be configured to the specific system requirements without first having to purchase a specific level switch.

This aids original equipment manufacturers and operators with project planning and logistics.

Since the level contacts are electric components, they require a connection to the respective circuits. This is typically achieved using cables which however, particularly in the case of multiple contacts, makes adjustments more difficult.

The Easy Just System is based on a wireless contact arrangement.

These are enclosed by different coloured housings and are arranged on a carrier board with gold contact points.

The different colours aid with coding the various contacts and ensure the terminal configuration matches the connectors.

The switching function of the contacts (NO or NC) is determined by turning the contact sleeve 180° on the carrier board.

Depending on the option selected, a fixed temperature switch (bi-metal, NO or NC), Pt 100 or 4-20 mA transmitter will be fixed to the bottom end of the board for temperature monitoring.