



S A F E T Y   A T   T H E   H I G H E S T   L E V E L

# KeeGuard Lite Operation & Maintenance Manual







## SAFETY GUARDRAIL SYSTEMS

The Company's guardrail system KEEGUARD has been designed specifically to provide permanent edge protection for areas where regular access for maintenance and inspection is required.

## UNIQUE SYSTEMS

Each system's unique design provides permanent edge protection without the need to mechanically fix the system through the roofing membrane or building's structure. Their simple cantilever principle provides unrivalled strength, stability and safety and overcomes the problems associated with traditional systems such as having to drill and puncture the roof membrane which can lead to potential penetrative water damage and noise disturbance during installation. Similarly, high levels of insulation included within warm deck and inverted flat roof designs often mean it is virtually impossible to fix through, as with traditional systems, without causing cold bridging. This may then cause interstitial condensation to form within the flat roof construction, causing the roof to deteriorate and eventually require replacement. When it is not appropriate to use counter balanced systems, such as modern industrial cladded pitched roofs, KeeGuard Topfix may be an alternative to traditionally fixed systems.



## DURABLE SYSTEMS

The Company's guardrail components are supplied with a galvanised finish carried out to BS EN ISO 1461 and ASTM A53: Hot Dip Galvanised Coatings Specification and Testing Methods, giving an average coating of between 65-85 microns. All products are also available in aluminium. All locking screws are stainless steel and are greased before fixing to ensure a maintenance free system.

## COMPONENT BASED SYSTEMS

All systems consist of galvanised/aluminium tubing joined together using the KEE KLAMP method of connection. KEEGUARD, raked, raked and folding systems' base feet connect to the 100% recycled PVC counter weight, giving the system its strength & stability.



## VERSATILE SYSTEMS

All systems have been specially designed to fit any shape and size of flat and pitched roofs, even circular designs. The systems can also cope with changes in levels, roof falls and difficult details such as ductwork passing over the roof edge and cable trays/plant mounted at the roof edge. The flexibility of the counter weight & KEE KLAMP design allows the systems to be used on plant congested or complex detailed roofs. The product range has been extended to suit specific requirements and includes the standard design with vertical legs, raked and raked systems, as well as a folding version for areas where a more discreet form of protection is required. KeeGuard Topfix has also been added to the range to provide collective protection solutions for industrial cladded pitched roofs.



## MEMBRANE PROTECTION SYSTEMS

Each system is installed with rubber matting bonded to the underside of metal components which come into contact with the roof membrane. In some cases the counter weight and base foot have sacrificial pads placed between the edge protection components and the roof membrane. This protects the roof membrane from damage via heat transfer or direct contact with components. On warm deck roof construction specifications pedestrian tiles are recommended to be placed where base feet and counter weights are in contact with the roof membrane. Where KeeGuard Topfix is installed a butyl strip is used where the Base Plates are fixed, via rivets, to the roof cladding.

## TESTING & CERTIFICATION

Tested in accordance with:-  
 EN 13374 Class A.  
 EN ISO 14122 Part 3.  
 NF E85-003  
 EN 1991-1-4  
 BS 6399 : Part 2 Code of Practice for Wind Load.

## WIND CALCULATED

Wind loading is the most likely regular and demanding force a free standing roof guardrail will encounter during its lifetime. The Company has developed a computerised programme to calculate the design to ensure compliance with the relevant wind loadings relating to the topography, height and location of the project throughout the World.

## OFFICIAL DOCUMENTATION

All Systems comply with the following:-  
 Work at Height Regulations.  
 HSG 33 "Health & Safety in Roof work"  
 HSE Construction Sheet No. 21 "Working on flat roofs protection against falls."  
 European Union Directives together with requirements of CDM Regulations.

## AESTHETICS

The smooth lines of the standard galvanised/aluminium finish can be further enhanced by the application of powder coating to BS 6497 Specification for Powder Organic Coatings, EU Codes with bespoke colour produced to special order. Counter weights are available in black or other colours at an additional cost. Where a more discreet form of protection is required, raked and radiused systems, as well as a folding version are welcomed by Planning Officers due to their improved aesthetics.

## SYSTEMS DISTRIBUTORS

All systems are available as a supply and installation service or component supply only. Products are available from the Company directly or one of its licensed distributors.

## INDUSTRIAL CLADDED ROOFS

The Company has developed a new collective roof edge protection system, KeeGuard Topfix specifically for metal profile and standing seam roofs up to 45°. Pitched cladded roofs have traditionally been protected using personal fall protection systems which are lower in the hierarchy of controls.

## PRODUCT SPECIFICATION - EN 13374

**FEATURES:-** Standard Vertical and Raked System.  
Recycled PVC Counter Weight System.

### GENERAL

KeeGuard® systems do not require physical fixing into the roof's structure/membrane. The complete system's design, manufacture, testing and installation has been externally assessed and tested to EN 13374.

### MATERIALS

Horizontal guardrails are produced in aluminium to BS EN 755 - 48.3mm external diameter (Wall thickness 4.05mm).

The vertical support legs are produced in aluminium to BS EN 755 - 48.3mm external diameter (Wall thickness 4.05mm).

Cantilever tubes are produced in steel - 42.4mm external diameter (Wall thickness 3.2mm). All cast clamps have Threadcoat applied to all tapped holes. All grub screws are carbon steel and have Keekoat protection applied to ensure minimal maintenance.

All cast clamps used to join the guardrail are high grade aluminium alloy to A356-T6.

Cast clamps used to join the Base Foot to the Cantilever Tubes are galvanised malleable cast iron produced to BS EN 1562 : founding malleable cast iron.

All metal components in contact with the roof membrane are covered with 3mm fluted rubber.

Counter weights are manufactured from recycled PVC.

Where steel tubing is cut on site zinc rich paint is applied to the cut end of the tube.

### LAYOUT

Height of guardrail is set at 1100mm. All vertical supports are set at maximum 3m centres depending on the system.

Recycled PVC counter weights are attached to every vertical leg set at no more than 3m centres. At corner Support Legs there is no need for a PVC Counter Weight to be connected.

All free standing ends are appropriately counter weighted according to roof pitch and membrane (see table) or supported by way of a wall/ladder clamp.

### TESTING

All systems have been tested to EN 13374: Temporary Edge Protection Systems – Product Specification Test Methods and have been awarded a Class A Pass.

### WIND LOADING

All installations are wind speed calculated to BS 6399 : Part 2 : Code of Practice for Wind Loads. Eurocode 1: Actions on structures - Part 1-4: General actions - Wind loads.



EN 13374								
Roof Type	MAX Pitch	Tube Size & Wall Thickness (Vertical)		Tube Size & Wall Thickness (Horizontal)		End Counter Balance No.'s	MAX Bay Centres	Intermediate Counter Balance No.'s
<b>Mineral Grade Felt</b>								
Unrestrained	10°	8	4.05mm	8	4.05mm	CB3P-25	3m	1
	5°	8	4.05mm	8	4.05mm	CB2P-25	3m	1

## PRODUCT SPECIFICATION - EN 14122-3 & NF E85-003

**FEATURES:-** Standard Vertical and Raked System.  
Recycled PVC Counter Weight System.

### GENERAL

KeeGuard® systems do not require physical fixing into the roof's structure/membrane. The complete system's design, manufacture, testing and installation has been externally assessed and tested to EN 14122-3 & NF E85-003.

### MATERIALS

Horizontal guardrails are produced in aluminium to BS EN 755 - 48.3mm external diameter (Wall thickness 4.05mm).

The vertical support legs are produced in aluminium to BS EN 755 - 48.3mm external diameter (Wall thickness 4.05mm).

Cantilever tubes are produced in steel - 42.4mm external diameter (Wall thickness 3.2mm). All cast clamps have Threadcoat applied to all tapped holes. All grub screws are carbon steel and have Keekoat protection applied to ensure minimal maintenance.

All cast clamps used to join the guardrail are high grade aluminium alloy to A356-T6.

Cast clamps used to join the Base Foot to the Cantilever Tubes are galvanised malleable cast iron produced to BS EN 1562 : founding malleable cast iron.

All metal components in contact with the roof membrane are covered with 3mm fluted rubber. Counter weights are manufactured from recycled PVC.

Where tubing is cut on site zinc rich paint is applied to the cut end of the tube.

### LAYOUT

Height of guardrail is set at 1100mm.

All vertical supports are set at maximum 2.4m centres depending on the system.

First bay of all installations vertical supports are set at maximum 2.0m centres.

Subsequent Vertical Supports set at maximum 2.4m.

Recycled PVC counter weights are attached to every vertical leg set at no more than 2.4m centres. At corner Support Legs there is no need for a PVC Counter Weight to be connected.

All free standing ends are appropriately counter weighted according to roof pitch and membrane (see table) or supported by way of a wall/ladder clamp.

### TESTING

All systems have been tested to EN 14122-3 & NF E85-003.

### WIND LOADING

All installations are wind speed calculated to Eurocode 1: Actions on structures - Part 1-4: General actions - Wind loads.



### EN 14122-3 & NF E85-003

Roof Type	MAX Pitch	Tube Size & Wall Thickness (Vertical)		Tube Size & Wall Thickness (Horizontal)		End Counter Balance No.'s	MAX End Bay Centres	Intermediate Counter Balance No.'s	MAX Subsequent Bay Lengths
<b>Mineral Grade Felt</b>									
Unrestrained	3°	8	4.05mm	8	4.05mm	CB4P-25	2m	1	2.4m

# Typical Edge Protection System Layout

FIGURE 1

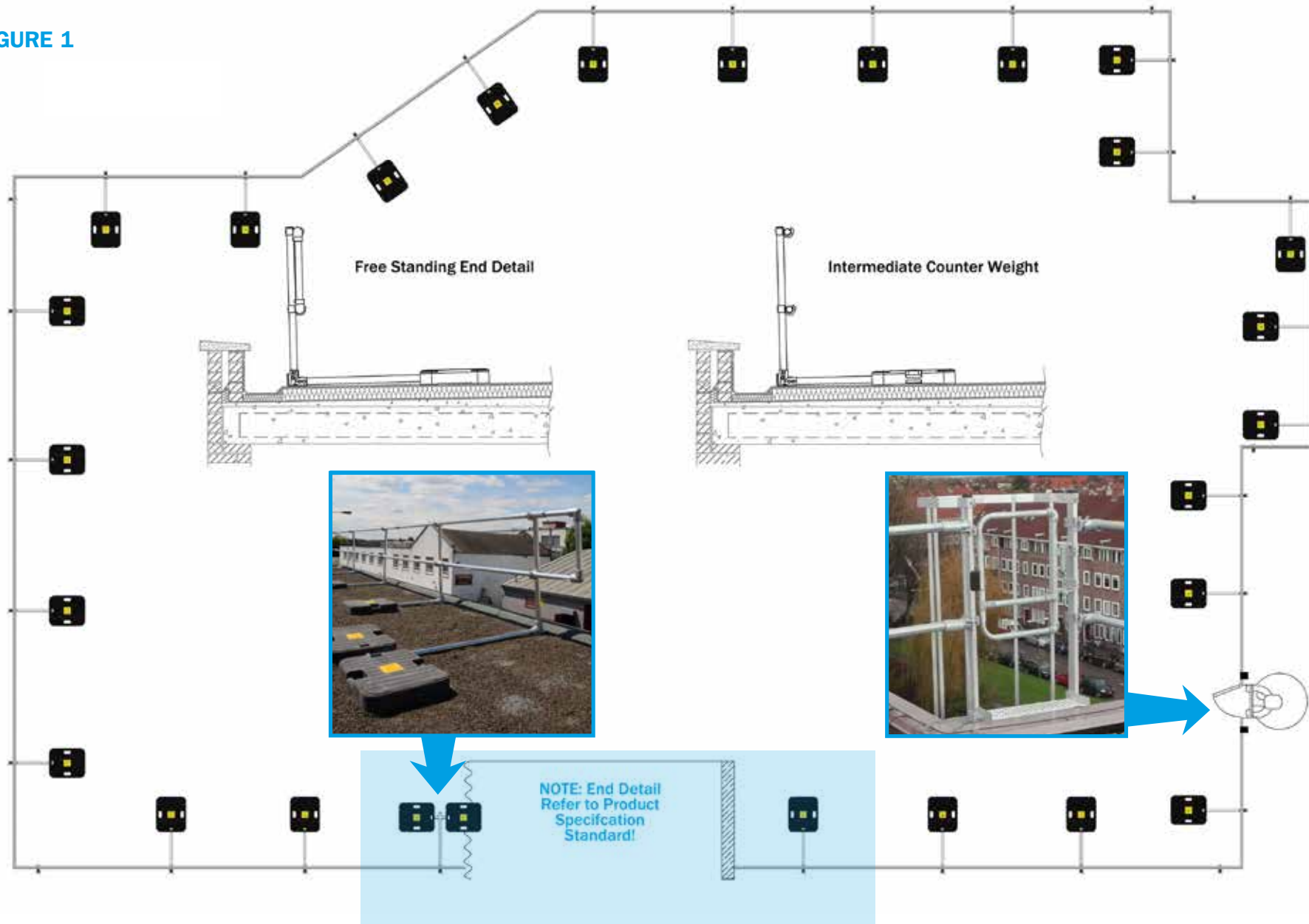

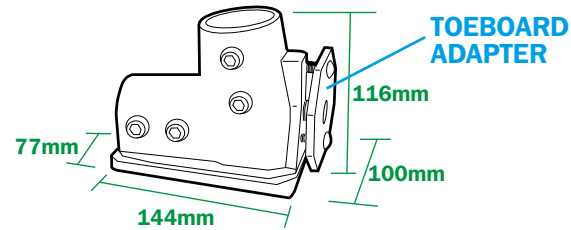

**\*BASE FOOT - 130-87514 (130-875T-TOE-BOARD-OPTION)**

This unique component provides support to the system and allows the system to be set at 90° or raked back at 11°. The Base Foot connects the Cantilever Tubes and Counter Weights. The base is bonded with fluted rubber matting for membrane protection.

Material : Malleable cast iron to BS 1562 and galvanised to BS EN ISO 1461. Net weight : 1.9kg.

**REPLACEMENT RUBBER PAD - K1351-4080**

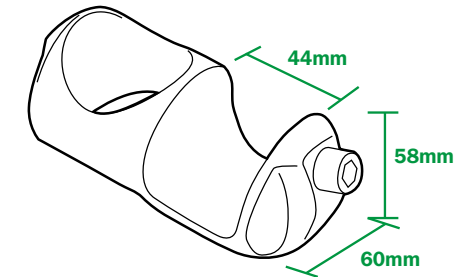

**\*SADDLE CLAMP - L135-8**

This open cup fitting provides the method of linking the horizontal Main Rail Tubes to the Support Legs. Material : High grade aluminium alloy to A356-T6. Net weight : 0.39kg.

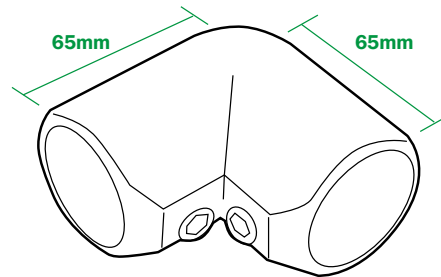

**90° ELBOW - L15-8**

This provides the means of dealing with corners and changes in level.

Material : High grade aluminium alloy to A356-T6. Net weight : 0.40kg.

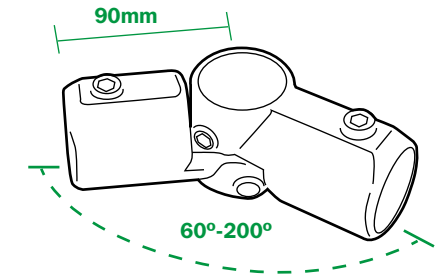

**ADJUSTABLE SIDE OUTLET TEE ELBOW - L19-8**

Used in pairs these components deal with angles 60°-200° and changes in level.

Material : High grade aluminium alloy to A356-T6. Net weight : 0.66kg.

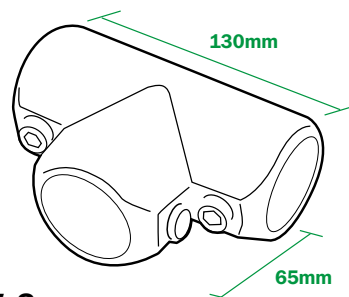

**THREE SOCKET TEE CONNECTOR - L25-8**

This component is used in many different instances, for example, to provide changes in level.

Material : High grade aluminium alloy to A356-T6. Net weight : 0.51kg.

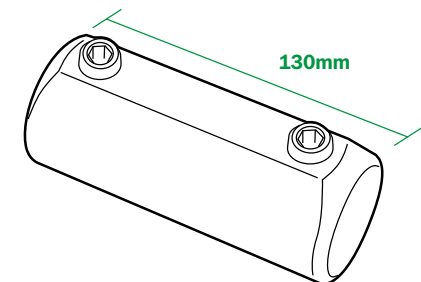

**STRAIGHT COUPLING - L14-8**

This component provides the method to link the horizontal Main Rail Tubes.

Material : High grade aluminium alloy to A356-T6.

Net weight : 0.34kg.

**\* Sold as replacement parts only**



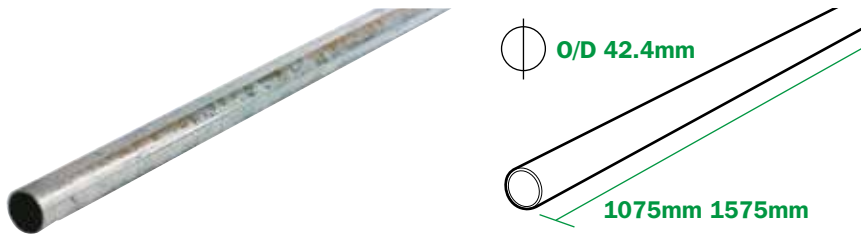

**CANTILEVER TUBE - (1075mm - CBT1) (1575mm - CBT2)**  
**CANTILEVER TUBE - (1075mm - CBT1) (1575mm - CBT2)**

This component provides the link between the Counter Weight and Base Foot.  
 Material : Steel tubing to EN 10255. All steel components galvanised to BS EN ISO 1461. Cantilever tubes are produced in steel – 42.4mm external diameter. (Wall thickness 4.05mm) First/last Cantilever tube length 1575mm Net weight : 4.48kg. Intermediate cantilever tube length 1075mm Net weight : 3.26kg.

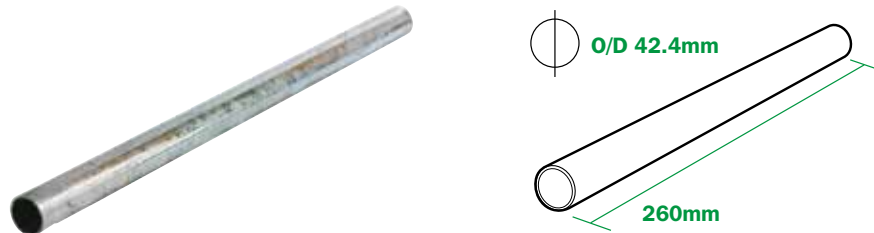

**SMALL CANTILEVER TUBE/COUNTER WEIGHT LINK - CBT3**

Used in pairs at the end details these components provide the link between the Counter Weights and the Cantilever Tube via the Two Socket Cross fitting. Material : Steel tubing to EN 10255. All steel components galvanised to BS EN ISO 1461. Tubes are produced in steel – 42.4mm external diameter. (Wall thickness 4.05mm) Net weight : 0.78kg.



**EN 13374 SPECIFICATION**

**MAIN RAIL TUBE (3.0m 8-4-AHL 285) (3.0m 8-4 AHL 285)**

Supplied in standard 3m lengths or cut to size for convenience, these components provide the horizontal rails of the system. Guardrail top and intermediate rails are produced in aluminium - 48.3mm external diameter. Wall thickness 2.85mm. Material : Aluminium to BS EN 755. Net weight : 1.1kg/m

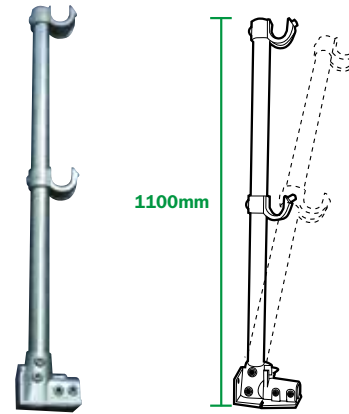

**EN 13374 SPECIFICATION  
 STANDARD SUPPORT LEG  
 - (KGU285)**

This component allows for standard 90° installation or raked back at 11° and provides some height adjustment to the system. The Vertical Support Legs are produced in aluminium - 48.3mm external diameter. Material : Aluminium BS EN 755. Net weight : 3.640kg

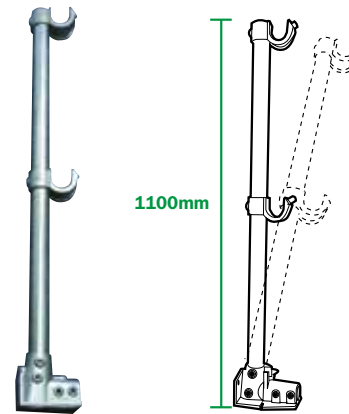

**EN 14122-3 SPECIFICATION  
 STANDARD, RAKED, RADIUSED &  
 BENT SUPPORT LEG  
 STANDARD - (KGU45)**

This component allows for standard 90° installation or raked back at 11° and provides some height adjustment to the system. The Vertical Support Legs are produced in aluminium - 48.3mm external diameter. Material : Aluminium BS EN 755. Net weight : 4.5kg.

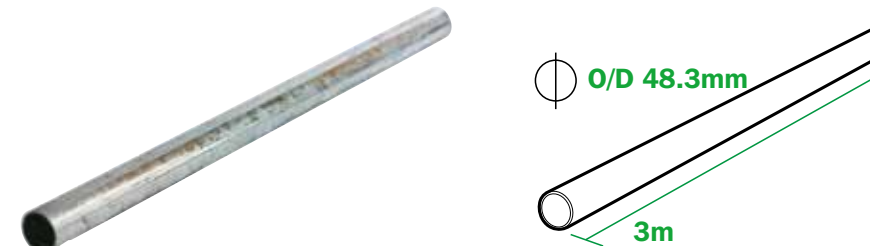

**EN 14122-3 SPECIFICATION**

**MAIN RAIL TUBE (3.0m 8-4 AHL) (Cut to size 8-4-AHL-per/m)**

Supplied in standard 3m lengths or cut to size for convenience, these components provide the horizontal rails of the system. Guardrail top and intermediate rails are produced in aluminium - 48.3mm external diameter. Wall thickness 4.05mm. Material : Aluminium to BS EN 755. Net weight : 1.17kg/m

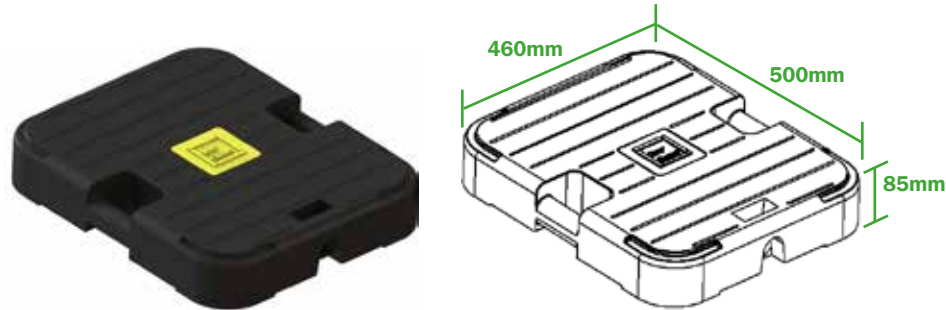

**\*RECYCLED PVC COUNTER WEIGHT - 440-7N**

This component provides the stability to the system.  
Material : Recycled PVC Net weight : 25kg.

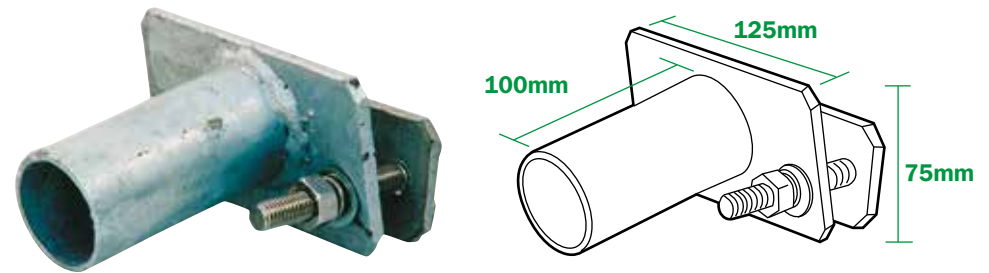

**WALL/LADDER CLAMP - SL109C**

This component provides the means to terminate the system against a façade or clamp the system to a cat ladder/structure where the stringer is a maximum of 70mm wide.  
Material : Galvanised steel to BS EN ISO 1461. Net weight : 1.1kg.

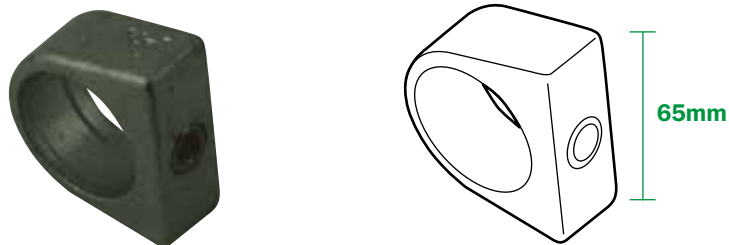

**COLLAR - 74-7**

This component is inserted in the first slot of the recycled PVC Counter Weight. The cantilever tube is pushed through this fitting and the grub screw is then tightened. This component provides the connection between the Cantilever Tube and the Counter Weight.  
Material : Malleable cast iron to BS 1562 and galvanised to BS EN ISO 1461. Net weight : 0.24kg.

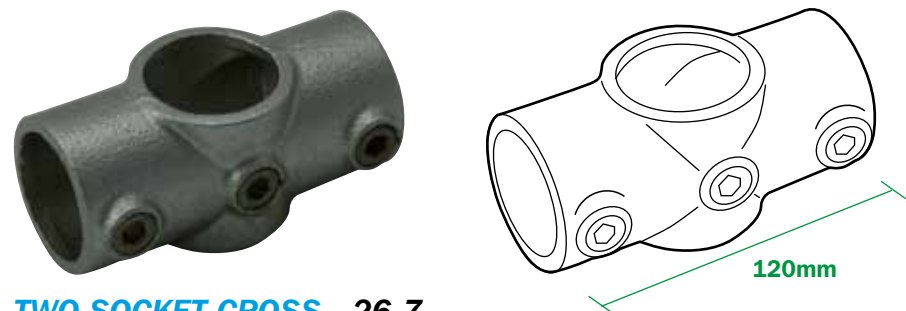

**TWO SOCKET CROSS - 26-7**

This component is used where two recycled PVC Counter Weights need to be joined together to form a counter weight end detail. Material : Malleable cast iron to BS 1562 and galvanised to BS EN ISO 1461. Net weight : 0.63kg.

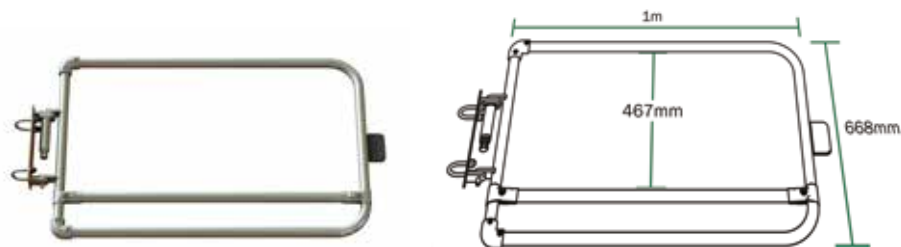

**European Gate - Galvanised - SGEU500GV**

Spring Loaded, self-closing safety gate. Manufactured from steel to EN 10255. 33.7mm diameter tube x 3.2mm wall thickness to meet requirements of EN 13374 & EN 14122. Complete with fixing pack.  
Material : Galvanised steel to BS EN ISO 1461. Net weight : 11kg (24lb 4oz).

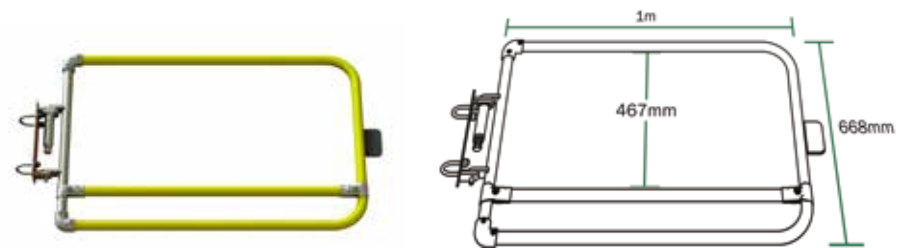

**European Gate – Powder Coated - SGEU500PC**

Spring Loaded, self-closing safety gate. Manufactured from steel to EN 10255 33.7mm diameter tube x 3.2mm wall thickness to meet requirements of EN 13374 & EN 14122. Complete with fixing pack. Powder Coated Finish to EN 13438.  
Material : Steel to EN 10255. Net weight : 11kg (24lb 4oz).

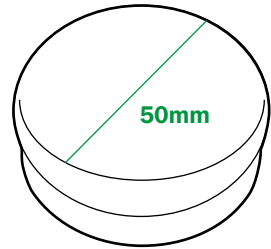

### PLASTIC CAP - 77-8

This component is fitted to the top of the Support Leg to prevent water ingress.  
Material : PVC. Net weight : 0.009kg.

**CANTILEVERED ROOF EDGE PROTECTION**  
SEPARATING PEOPLE FROM HAZARDS

**HEAD OFFICE**  
Kee Safety Limited  
Cradley Business Park  
Overend Road  
Cradley Heath  
West Midlands B64 7DW

(t) +44 (0) 1384 632 188  
(f) +44 (0) 1384 632 192  
(e) info@keesafety.co.uk  
(w) www.keesafety.co.uk

- THIS GUARDRAIL IS TESTED TO EN 13374/EN 14122-3
- DO NOT REMOVE, TAMPER, ADJUST, REMOVE OR ALTER IN ANY WAY THE GUARDRAIL INSTALLATION WITHOUT FIRST CONSULTING KEE SAFETY.
- NO LANYARD LIFE LINE OR FALL ARREST PRODUCTS TO BE ATTACHED TO THE GUARDRAIL AT ANY TIME
- DO NOT ATTACH PLASTIC SHEETING OR ANYTHING THAT WOULD INCREASE THE WIND LOADING ON THE GUARDRAIL.
- IF YOU FIND THE GUARDRAIL HAS BEEN ALTERED OR TAMPERED WITH, CONTACT KEE SAFETY IMMEDIATELY

• RE-TEST ONLY TO BE CARRIED OUT BY AUTHORISED SERVICE AGENT.

### SYSTEM PLAQUE - SL 111

Provides details of the system and approvals. Material : Plastic. Net weight : 0.085kg.



## STANDARD - (KGU285)

These are supplied already assembled at the correct height (1100mm) with the Base Foot & saddle Clamps set at the correct position.



## LAYING OUT SUPPORT LEG AND MAIN RAIL TUBES

Lay out the equipment in approximately the positions shown below. Always ensure that you and the equipment are at a safe distance from the roof edge. It is recommended that this distance is no less than 2m (6'6").

Lay out two 3.0 m Main Rail Tubes side by side and in a continual line, for the whole length of the required guardrail (ensure these do not roll towards the roof edge). Then start laying out the Support leg Units. If your start position is from a corner, start laying out the support legs at a maximum of the following centres (EN 13374 - 3m centres) (EN 14122-3 - 2.4m centres). Please refer to technical specification. Carry on laying out the Support Legs for the required length of guardrail.

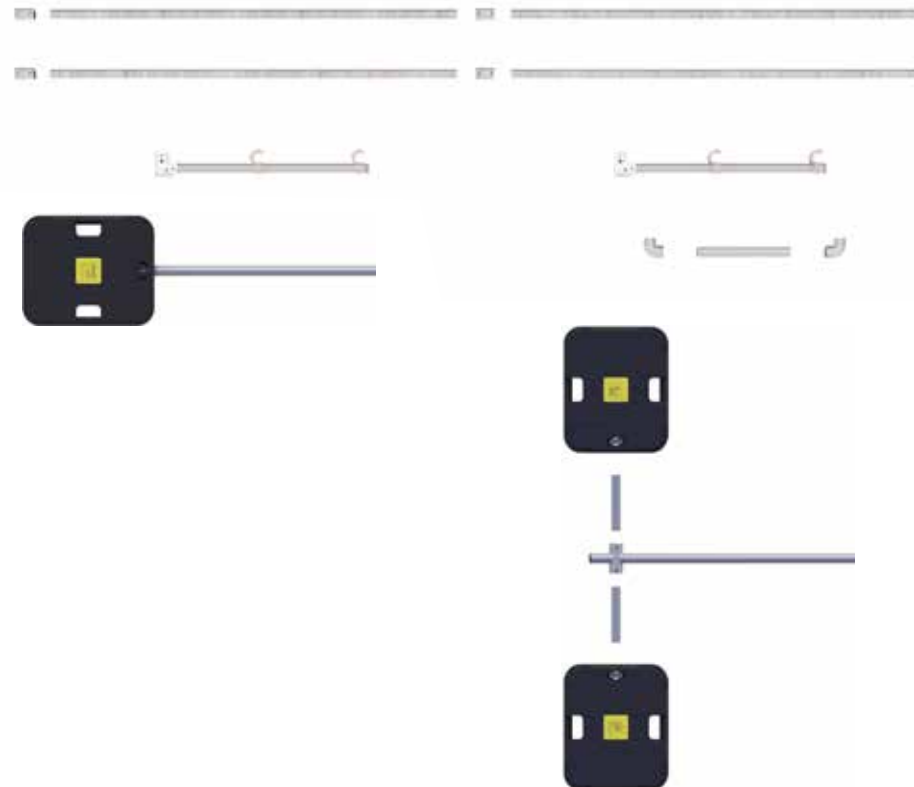

## Fixed, Free Standing and Intermediate Details

(See tables and specifications)



### A

#### SELF CLOSING GATE ACCESS POINT

Extra components

- 1-2No. Support Legs (Position of break Dependent)
- 1No. Self Closing Gate (SGEUPC2)
- 4No. 90° Elbows (L15-8)
- 2No. End pieces

- 4No. PVC Counter Weights (440-7N) (EN 13374)
- 2No. Cantilever Tube (CBT2P-25)
- 4No. Small Cantilever Tube Link (CBT3P-25)
- 2No. Two Socket Cross (26-7)
- 4No. Collars (74-7)

- 8No. PVC Counter Weights (440-7N) (EN 14122-3)
- 2No. Cantilever Tube (CBT2)
- 8No. Small Cantilever Tube Link (CBT3P-25)
- 4No. Two Socket Cross (26-7)
- 8No. Collars (74-7)



### B

#### FREE STANDING END

Extra components

- 2No. 90° Elbows (L15-8)
- 1No. End piece

- 2No. PVC Counter Weights (440-7N) EN 13374)
- 1No. Cantilever Tube (CBT2P-25)
- 2No. Small cantilever Tube Link (CBT3P-25)
- 1No. Two Socket Cross (26-7)
- 1No. Collars (74-7)

- 4No. PVC Counter Weights (440-7) EN 14122)
- 1No. Cantilever Tube (CBT2P-25)
- 4No. Small cantilever Tube Link (CBT3P-25)
- 2No. Two Socket Cross (26-7)
- 4No. Collars (74-7)



### C

#### WALL CLAMP

Extra components

- 1No. End piece
- 1No. Three Socket Tee Connector (25-8)
- 1No. Wall/Ladder Clamp (SL109C)
- 2No. 90° Elbows (L15-8)
- 2No. Wall Fixings (SL110)

## FIXED, FREE STANDING AND INTERMEDIATE DETAILS LAYING OUT LAYING OUT COUNTER WEIGHTS AND CANTILEVER TUBES

Where the 2No. Main Rail Tubes butt together lay out 2No. Straight Couplings (L14-8) in order for the Main Rail Tubes to be joined. At corners 2No. 90° Elbows will be used (L15-8). (Use Adjustable Side Outlet Tee Elbows in pairs where corners are 60° - 200 ° (L19-8)). See also Fixed, Free Standing and Intermediate Details above for additional required components. (See Figure1.)

### EN13374

At any free standing end detail Support Leg, place 1No. Cantilever Tube (CBT2), 1No. Two Socket Cross Clamp (26-7), 2No. Small Cantilever Tubes (CBT3), 2No. PVC Counter Weights (440-7N) and 2No. Collars (74-7)

At the intermediate Support Legs (max 3m centres) place 1No. Cantilever Tube (CBT1), 1No. PVC Counter Weight (440-7N), and 1No. Collar (74-7). At corner Support Legs there is no need for a PVC Counter Weight to be connected (See Figure1 and specification.).

### EN 14122-3

At any free standing end detail Support Leg, place 1No. Cantilever Tube (CBT2), 2No. Two Socket Cross Clamp (26-7), 4No. Small Cantilever Tubes (CBT3), 4No. PVC Counter Weights (440-7N) and 4No. Collars (74-7)

At the intermediate Support Legs (First bay max 2m centres) (Subsequent bays max 2.4m centres) place 1No. Cantilever Tube (CBT1), 1No. PVC Counter Weight (440-7N), and 1No. Collar (74-7). (See Figure1 and specification).

## LAYING OUT FITTINGS

Where the 2No. Main Rail Tubes butt together lay out 2No. Straight Couplings (L14-8) in order for the Main Rail Tubes to be joined. At corners 2No. 90° Elbows will be used (L15-8). (Use Adjustable Side Outlet Tee Elbows in pairs where corners are 60° - 200 ° (L19-8)). See also Fixed, Free Standing and Intermediate Details above for additional required components. (See Figure1.)

EN 13374								
Roof Type	MAX Pitch	Tube Size & Wall Thickness (Vertical)		Tube Size & Wall Thickness (Horizontal)		End Counter Balance No.'s	MAX Bay Centres	Intermediate Counter Balance No.'s
<b>Mineral Grade Felt</b>								
Unrestrained	10°	8	4.05mm	8	4.05mm	CB3P-25	3m	1
	5°	8	4.05mm	8	4.05mm	CB2P-25	3m	1

EN 14122-3 & NF E85-003									
Roof Type	MAX Pitch	Tube Size & Wall Thickness (Vertical)		Tube Size & Wall Thickness (Horizontal)		End Counter Balance No.'s	MAX End Bay Centres	Intermediate Counter Balance No.'s	MAX Subsequent Bay Lengths
<b>Mineral Grade Felt</b>									
Unrestrained	3°	8	4.05mm	8	4.05mm	CB4P-25	2m	1	2.4m



## STAGE 1

Starting at least 2m away from the roof edge at the corner, stand up the two Support Legs.



## STAGE 2

Place a Main Rail Tube (8-4-AHL) into the bottom Saddle Clamp (L135-88) of each of the standing legs. Position the tube so there is at least 60mm protruding from the Saddle Clamp (L135-88) and tighten the Grub Screw. These are located on the front of the Saddle Clamp (L135-88). Place the second Main Rail Tube (8-4-AHL) into the top Saddle Clamp (L135-88), positioning the tube as before, leaving at least 60mm of the tube protruding from the Saddle Clamp (L135-88) and tighten the Grub Screw of the Saddle Clamp (L135-88).



## STAGE 3

Form a corner via connecting 2No 90° Elbows (L15-88) to one end of each of the Main Rail Tubes (8-4-AHL). Position a further Support Leg (3m max – EN 13374) (2.4m max – EN 14122-3) Slide a Main Rail Tube (8-4-AHL) into the bottom Saddle Clamp (L135-88) and 90° Elbow (L15-8).

Slide a Main Rail Tube (8-4-AHL) into the top Saddle Clamp (L135-88) and 90° Elbow (L15-8). Tighten the grub screws of all clamps.



## STAGE 4

Working in pairs carefully lift the assembled bay and walk towards the leading edge. Carefully place the bay in the desired position and slide the corresponding Counter Weight tube into the Base Foot. (CBT1P-25 (Intermediate Support Leg or CBT2P-25 (Free Standing End Detail)). Always ensure the bay is being held in position whilst carrying out this part of the assembly. At corner Support Legs there is no need for a PVC Counter Weight to be connected.



## STAGE 5

Intermediate support Legs/PVC Counter Weights Slide 1No. Cantilever Tube (CBT1) into the Base Foot. Do not tighten at this stage. Place 1No. Collar (74-7) in the front slot of the PVC Counter Weight. Slide 1No. PVC Counter Weight on to the free end of the Cantilever Tube (CBT1). Line and level guardrail. Tighten all grub screws.

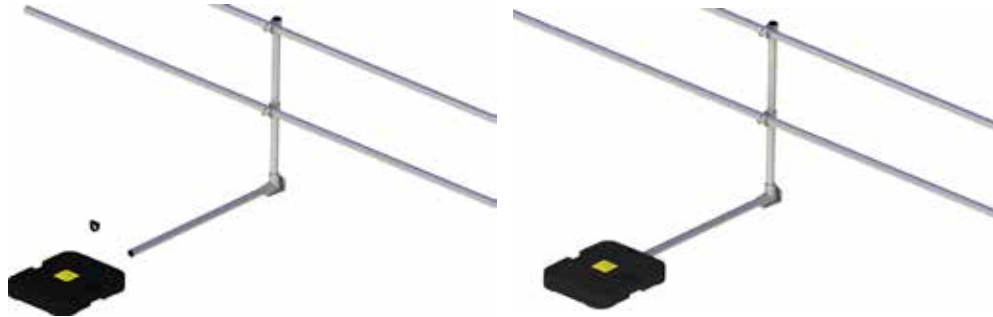

## STAGE 6

Working away from the corner slide a Straight Coupling (L14-8) on to the top and intermediate Main Rail Tubes. Ensure the Straight Couplings (14-8) are off set as shown. As far as possible only use one Straight Coupling (14-8) per bay. Position the clamp so the grub screws are facing outwards and tighten the Grub Screw at the connected end. Stand up the next Support Leg at the desired position (3m max – EN 13374) (2.4m max – EN 14122-3). Continue with this method of fitting the Main Rail Tube (8-4-AHL) and Support Legs together for this run of guardrail, remembering to connect the intermediate Cantilever Tubes (CBT1) and PVC Counter Weights (New Code) to the Support Legs as you proceed.



## STAGE 7

Free Standing End Details (Refer to tables within specification page)

### EN 13374

Slide 1No. Two Socket Cross (26-7) on to the free end of the Cantilever Tube (CBT2). Do not Tighten at this stage. Slide 2No. Small Cantilever Tubes into the free ends of the Two Socket Cross (26-7) and tighten the grub screws holding these tubes into position. Place 1No. Collar (74-7) in the front slot of each PVC Counter Weight. Slide 1No. PVC Counter Weight on to the free end of the Cantilever Tube (CBT2). Slide 1No. PVC Counter Weight on to each of the free ends of the Small Cantilever Tube (CBT3).

### EN 14122-3

Slide 3No. Two Socket Cross (26-7) on to the free end of the Cantilever Tube (CBT2). Do not tighten at this stage. Slide 6No. Small Cantilever Tubes into the free ends of each of the Two Socket Cross (26-7) and tighten the grub screws holding these tubes into position. Place 1No. Collar (74-7) in the front slot of each PVC Counter Weight. Slide 1No. PVC Counter Weight on to each of the free ends of the Small Cantilever Tube (CBT3).

Position all PVC Counter Weights as far from the Base Foot (130-87514) as practically possible. Line and level guardrail. Tighten all grub screws. (See Fixed, Free Standing and intermediate Details).

## WARNING

Under no circumstances should any person be anchored to the system for fall arrest purposes. Further, components such as timber infill, advertising boards, polyethylene sheets must not be fixed to the system.



# KeeGuard Lite Assembly Guide

## EN 13374

Roof Type	MAX Pitch	Tube Size & Wall Thickness (Vertical)		Tube Size & Wall Thickness (Horizontal)		End Counter Balance No.'s	MAX Bay Centres	Intermediate Counter Balance No.'s
<b>Mineral Grade Felt</b>								
Unrestrained	10°	8	4.05mm	8	4.05mm	CB3P-25	3m	1
	5°	8	4.05mm	8	4.05mm	CB2P-25	3m	1

## EN 14122-3 & NF E85-003

Roof Type	MAX Pitch	Tube Size & Wall Thickness (Vertical)		Tube Size & Wall Thickness (Horizontal)		End Counter Balance No.'s	MAX End Bay Centres	Intermediate Counter Balance No.'s	MAX Subsequent Bay Lengths
<b>Mineral Grade Felt</b>									
Unrestrained	3°	8	4.05mm	8	4.05mm	CB4P-25	2m	1	2.4m



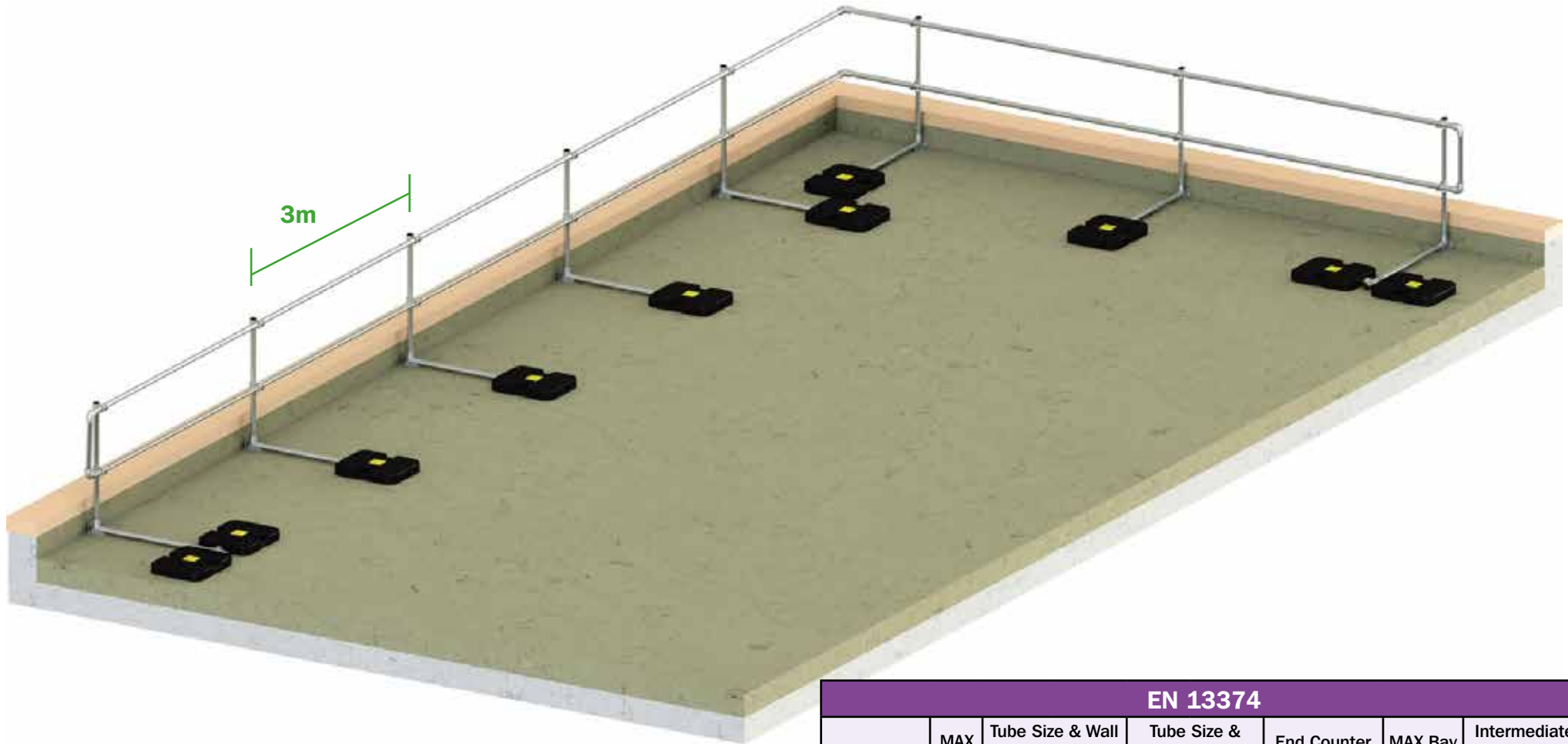

EN 13374								
Roof Type	MAX Pitch	Tube Size & Wall Thickness (Vertical)		Tube Size & Wall Thickness (Horizontal)		End Counter Balance No.'s	MAX Bay Centres	Intermediate Counter Balance No.'s
<b>Mineral Grade Felt</b>								
Unrestrained	10°	8	4.05mm	8	4.05mm	CB3P-25	3m	1
	5°	8	4.05mm	8	4.05mm	CB2P-25	3m	1

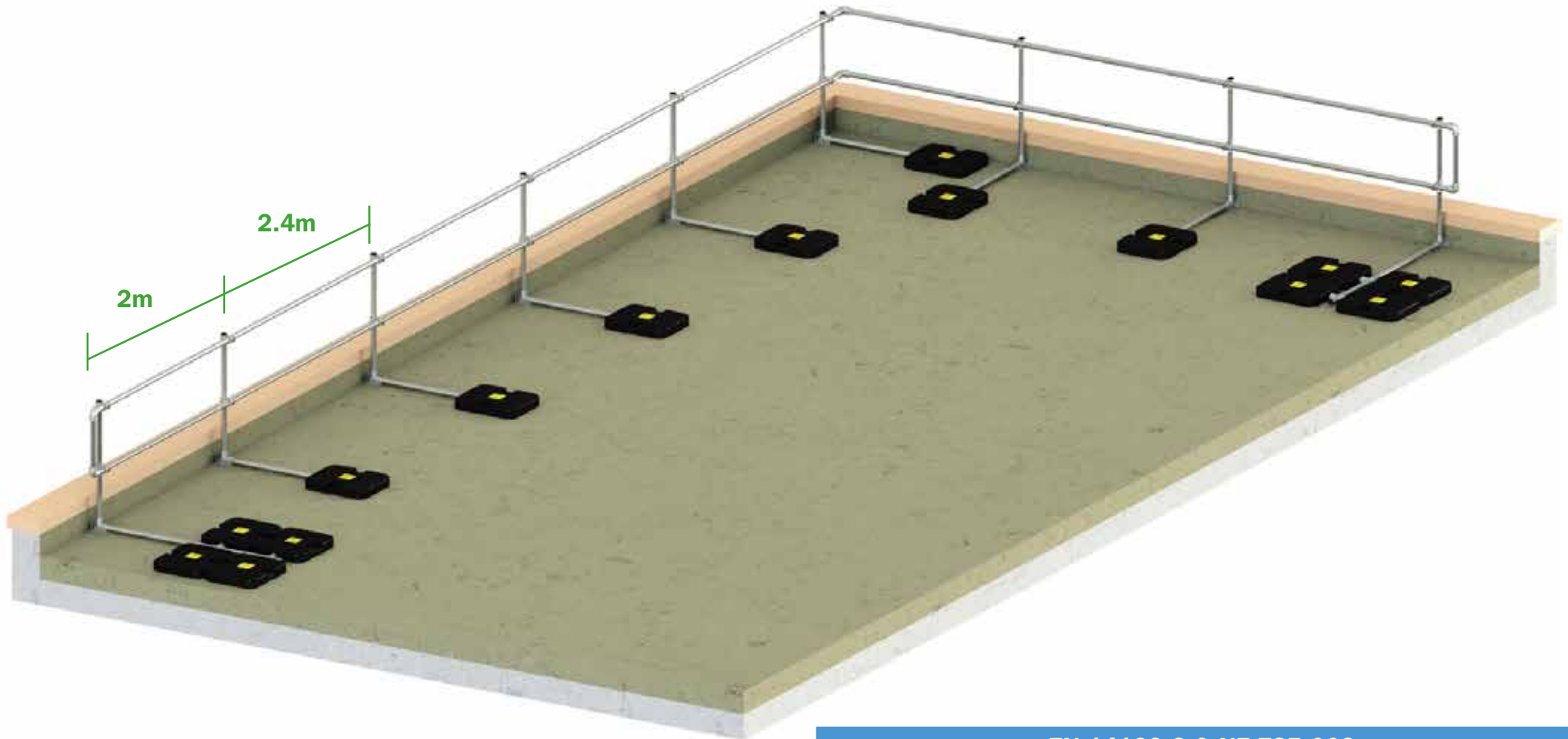

EN 14122-3 & NF E85-003									
Roof Type	MAX Pitch	Tube Size & Wall Thickness (Vertical)		Tube Size & Wall Thickness (Horizontal)		End Counter Balance No.'s	MAX End Bay Centres	Intermediate Counter Balance No.'s	MAX Subsequent Bay Lengths
<b>Mineral Grade Felt</b>									
Unrestrained	3°	8	4.05mm	8	4.05mm	CB4P-25	2m	1	2.4m



# Guardrail Systems Recertification

- Periodic inspections by a competent person are recommended by the manufacturer. In UK/Europe these are required under Regulation 5 of the Workplace (Health, Safety & Welfare) Regulations, the Work at Height Regulations and BS EN 365. The frequency will depend upon the environment, location and usage but should be at least every 12 months.
- Walk and visually inspect the complete installed system in relation to the general client's needs. Establish if any modifications and/or additional products are required to reflect any refurbishment requirements or additional plant & equipment which have been installed and require access.
- Check installation configuration is complete as per the original installation drawing/plan.
- Ensure the system has not been modified or tampered with by unauthorised persons.
- Check all base feet are in contact with the roof membrane.
- Check all counter weights are in place as per the original drawing. This is essential for wind loading calculations.
- Check all grub screws are in place, greased and sufficiently torque.
- Check that the general height and level of the system including the leg centres.

(This only tends to be an issue if the system has been tampered with between inspections).



Scan this QR Code to find out more about Kee Safety products.



**Kee Safety Limited**  
Cradley Business Park  
Overend Road, Cradley Heath  
West Midlands B64 7DW

**Phone: +44 (0) 1384 632 188**  
Fax: +44 (0) 1384 632 192  
sales@keesafety.com  
[www.keesafety.co.uk](http://www.keesafety.co.uk)